

Path Tableaux and the Combinatorics of the Immanant Function

by

Rebecca Tessier

A thesis
presented to the University of Waterloo
in fulfillment of the
thesis requirement for the degree of
Master of Mathematics
in
Combinatorics and Optimization

Waterloo, Ontario, Canada, 2013

© Rebecca Tessier 2013

I hereby declare that I am the sole author of this thesis. This is a true copy of the thesis, including any required final revisions, as accepted by my examiners.

I understand that my thesis may be made electronically available to the public.

Abstract

Immanants are a generalization of the well-studied determinant and permanent. Although the combinatorial interpretations for the determinant and permanent have been studied in excess, there remain few combinatorial interpretations for the immanant.

The main objective of this thesis is to consider the immanant, and its possible combinatorial interpretations, in terms of recursive structures on the character. This thesis presents a comprehensive view of previous interpretations of immanants. Furthermore, it discusses algebraic techniques that may be used to investigate further into the combinatorial aspects of the immanant.

We consider the Temperley-Lieb algebra and the class of immanants over the elements of this algebra. Combinatorial tools including the Temperley-Lieb algebra and Kauffman diagrams will be used in a number of interpretations. In particular, we extend some results for the permanent and determinant based on the R -weighted planar network construction, where R is a convenient ring, by Clearman, Shelton, and Skandera. This thesis also presents some cases in which this construction cannot be extended. Finally, we present some extensions to combinatorial interpretations on certain classes of tableaux, as well as certain classes of matrices.

Acknowledgements

I would like to thank my supervisor David Jackson for his continued guidance and assistance throughout my degree. I would also like to thank my readers, Kevin Purbhoo and David Wagner, for their insightful comments and observations. In addition, I also thank Mark Skandera for generously allowing me access to his preprint.

I acknowledge the Department of Combinatorics and Optimization for all of the support I received. Lastly, I am grateful to the University of Waterloo and the Government of Ontario Ministry of Training, Colleges and Universities for providing funding for my graduate studies.

Dedication

This is dedicated to all of my friends and family who have supported me throughout my studies.

Table of Contents

List of Figures	ix
List of Symbols	xi
1 Background	1
1.1 Introduction	1
1.2 The Symmetric Group and Representations	3
1.2.1 The Symmetric Group	3
1.2.2 Representations	3
1.2.3 Group Characters	5
1.3 Young Tableaux	5
1.3.1 Ferrers Diagrams and Young Tableaux	6
1.3.2 Littlewood-Richardson Coefficient	7
1.3.3 Hooks	8
1.4 Symmetric Functions	10
1.4.1 Jacobi-Trudi	14
1.5 Immanants of Symmetric Functions	15
1.6 Graph Theory	17
1.7 Complexity of Computing Immanants	20
1.8 Positivity of Matrices and Immanants	22
1.9 Supporting Computer Programs	23
1.10 Outline	23

2	Previous Combinatorial Interpretations	25
2.1	Combinatorial Interpretations of Permanents and Determinants	25
2.1.1	Permanents and Bipartite Graphs	25
2.1.2	Permanents and Cycle Covers	26
2.1.3	Lattice Paths and the Determinant	27
2.2	Combinatorial Interpretations of Immanants	31
2.2.1	Combinatorial Interpretation of Jacobi-Trudi Immanants as Lattice Paths	32
2.2.2	Combinatorial Interpretations for Immanants and the Matrix Tree Theorem	36
2.3	Temperley-Lieb Immanants	41
2.3.1	Colourings of the Temperley-Lieb Algebra	43
2.4	Path Tableaux and Immanants	45
2.4.1	Planar Networks	45
2.4.2	Path Tableaux	46
2.5	Immanant Interpretations	47
3	Recursive Formulations for Immanants	52
3.1	Branching Rule and Preliminaries	53
3.2	Recursive Constructions for Immanants	55
4	Combinatorial Interpretations derived from Recursive Formulations	61
4.1	Interpretations for Immanants on Certain Classes of Matrices	61
4.2	Interpretations for Permanents and Determinants	64
4.3	Interpretations for Hook Additions	67
4.3.1	Cell Additions on Hooks	73
4.4	Interpretations for Step Tableaux	74

5	Future Work, Related Problems, and Conclusions	75
5.1	Summary of Contributions	75
5.1.1	Related Research	77
5.2	Future Research	77
5.2.1	Further Combinatorial Interpretations	78
5.2.2	Conclusions	79
	APPENDICES	80
A	Maple Code for Immanants and Planar Networks	81
A.1	Code	81
A.1.1	Immanant Module	81
A.1.2	Planar Network Module	83
	Bibliography	87

List of Figures

1.1	A Ferrers Diagram $(3,3,2,1)$ and its conjugate $(4,3,2)$	6
1.2	A Standard Young Tableau and a Semistandard Young Tableau with $n = 9$	7
1.3	A skew tableau with $\lambda = (5, 4, 3)$ and $\mu = (3, 2)$	7
1.4	A Hook and a rim hook	9
1.5	The Hook-length $h_{2,3}$ of the cell $(2, 3)$ in a tableau.	9
1.6	A directed acyclic graph G	18
1.7	A planar graph and a non-planar graph.	18
1.8	A tree.	18
1.9	A connected weighted graph G with cycle cover $\{(5, 4, 3, 2, 1), (6, 7, 8, 9, 10)\}$	19
1.10	An example of arithmetic circuits with the x_i denoting the inputs.	21
2.1	An example of a directed, acyclic graph that may be associated with the Gessel, Viennot, and Lindström interpretation for the determinant.	29
2.2	Lattice Path Interpretation of Immanants with $\beta = (0, 2, 2, 0, \dots)$	35
2.3	The functional digraph of g	37
2.4	A standard tableau T and the two corresponding μ -canonical subtableaux.	40
2.5	Generators of the Temperley-Lieb Algebra.	42
2.6	The elements of $\mathfrak{TL}_n(2)$	43
2.7	Multiplication of elements $t_3 t_2 t_3 t_3 t_1 = 2 t_1 t_3$	44
2.8	Some colourings of the Temperley-Lieb Algebra $\mathfrak{TL}_4(2)$. The leftmost is the colouring for $\lambda = (3, 1)$ and the two right are colourings for $\lambda = (2, 2)$	44

2.9	Matrix and corresponding R -weighted planar network.	46
2.10	Poset ordering of a path family of type 1.	47
2.11	Six column strict path tableaux corresponding to the R -weighted planar network G . The first four are also semistandard path tableaux.	47
2.12	A special ribbon diagram with $\mu = (1, 2, 3, 4)$ and $\lambda = (3, 7)$	48
3.1	Inner and outer corners of a tableau.	53
4.1	Addition on a hook $\lambda = (2, 1)$	67
4.2	Counterexample to the R -weighted planar network construction, in the general case.	69
4.3	Sixteen semistandard path tableaux corresponding to the R -weighted planar network G	70
4.4	Additions for Hook Tableaux.	73
4.5	Step Tableaux $\lambda = (4, 3, 2, 1)$ and $\mu = (3, 2, 1)$	74

List of Symbols

\mathfrak{S}_n	Symmetric Group	3
$[n]$	The integers $\{1, \dots, n\}$	3
${}_R M$	R -Module	4
\mathbb{C}	Complex Numbers	4
\mathfrak{C}_μ	Conjugacy Class	3
$F[G]$	Group Algebra	3
k_μ	Size of Conjugacy Class	5
S^λ	Specht Module	4
$\chi \downarrow_H^G$	Restriction of a character from G to H	5
$\chi \uparrow_H^G$	Induction of a character from G to H	5
λ'	Conjugate partition of λ	6
$c_{\mu\nu}^\lambda$	Littlewood-Richardson Coefficient	8
λ/μ	Skew Partition	7
f_λ	Number of Standard Young Tableau with shape λ	9
$h_{i,j}$	Hook-length of a cell (i, j)	9
$l(\xi)$	Leg Length of a rim hook ξ	10
$\lambda \setminus \xi$	Partition λ with rim hook ξ removed	10
$[x^k]$	Coefficient Operator	11
\mathbb{Q}	Rational Numbers	11
p_k	Power Sum Symmetric Functions	11
e_k	Elementary Symmetric Functions	11
m_λ	Monomial Symmetric Functions	11
h_λ	Complete Homogeneous Symmetric Functions	12
s_λ	Schur Functions	12
χ_μ^λ	Character of the Symmetric Group	13
$M_n(F)$	The $n \times n$ Matrices over F	15
$H(\nu, \mu)$	Jacobi-Trudi Matrix	14
ch	Characteristic map	16

ϕ^λ	Monomial Character	16
ϵ^λ	Elementary Character	16
$M(G)$	Set of Perfect matchings in G	26
\mathfrak{P}_σ	Path Family type σ	61
SPT	Standard Path Tableaux	64

Chapter 1

Background

1.1 Introduction

In the past thirty years, there has been a resurgence of interest in a matrix function called an “immanant”. The term immanant was introduced by Littlewood in [26], as a generalization of the determinant and permanent using characters of irreducible representations of the symmetric group. There is significant interest in the immanant as it has uses in several branches of mathematics and its applications. For example:

- (i) the immanant and its special cases are often used in complexity theory as the determinant has a polynomial time algorithm [5], while the permanent can be used to show the completeness of certain combinatorial objects [4];
- (ii) immanants have been used in finite point processes as the determinant and permanent correspond to the fermion and boson point processes, respectively, leading to increased interest in the study of immanants in probability theory [9];
- (iii) significant research has been completed on the positivity of immanants [34], relating to the useful properties achievable with the positivity of determinants [22].

However, until Goulden and Jackson published “Immanants of Combinatorial Matrices” [15], the combinatorial aspect of immanants had received little attention. Goulden and Jackson’s paper revitalized interest in conjectures on the immanant. In “Some Conjectures on Immanants” [35], Stembridge made conjectures on the positivity of immanants and considered matrices which were totally nonnegative.

A matrix is defined to be **Totally Nonnegative** (TNN) if the determinant of all of its square submatrices are positive. Although significant work had been done on determining the nonnegativity of determinants, little had been done until Goulden and Jackson made conjectures on immanants being monomial nonnegative [15]. This conjecture then led to Stembridge's conjectures on further results for the positivity of immanants, which were later proved by Greene [18], Stembridge [34], and Haiman [19].

From these positivity results, it was natural to look for combinatorial interpretations of the immanant. There have been several previous combinatorial interpretations for both the permanent and the determinant functions. A significant interpretation is that of Gessel, Viennot, and Lindström for the determinant ([13], [25]), as a discretization of the Karlin-McGregor Theorem for simultaneous stochastic processes [22]. There have also been other interpretations for the permanent, such as Valiant's [37] interpretation used in the complexity proofs of the permanent.

There have been advancements in a number of significant special cases of combinatorial interpretations of the immanant. For example, the immanants of Jacobi-Trudi matrices and Matrix Tree Theorem matrices have been interpreted using graph theoretic concepts, such as lattice paths and trees. In addition, Clearman, Shelton, and Skandera [8] have an interpretation, in terms of planar networks, for all irreducible character immanants indexed by hook tableaux.

The main objective of this thesis is to consider the immanant and its possible combinatorial interpretations, in terms of recursive structures on the character. This thesis presents a comprehensive view of existing interpretations of immanants. Furthermore, it discusses algebraic techniques that may be used to investigate into the combinatorial aspects of the immanant. It also considers the Temperley-Lieb algebra and the class of immanants over the elements of this algebra.

Combinatorial tools including the Temperley-Lieb algebra, path tableaux, and Kauffman diagrams will be examined in previous interpretations. In particular, we extend some results for the permanent and determinant based on the R -weighted planar network construction, where R is a convenient ring, by Clearman, Shelton, and Skandera in [8]. This thesis also presents some cases in which this construction cannot be extended. Finally, we present some extensions to combinatorial interpretations on rectangular and step tableaux, as well as immanants on block diagonal matrices.

1.2 The Symmetric Group and Representations

This section begins with a brief introduction of concepts and definitions that will be used throughout the thesis.

1.2.1 The Symmetric Group

The symmetric group \mathfrak{S}_n on n elements is the set of all bijections $\sigma : \{1, 2, \dots, n\} \rightarrow \{1, 2, \dots, n\}$ with multiplication defined by composition. We shall denote the set $\{1, 2, \dots, n\}$ by $[n]$, and refer to the elements of \mathfrak{S}_n as permutations when they are to be regarded as combinatorial objects. The cycle type of each permutation can be represented as an integer partition consisting of the ordered list of cycle lengths in the disjoint cycle decomposition of a permutation.

A **partition**, $\lambda = (\lambda_1, \lambda_2, \dots)$ of n is an ordered tuple of nonnegative integers with $\lambda_1 \geq \lambda_2 \geq \dots \geq 0$ and $\lambda_1 + \lambda_2 + \dots = n$, with a finite number of the λ_i not equal to 0. The sum of the parts of λ is denoted by $|\lambda|$. The partitions of n are a natural indexing set of the conjugacy classes of \mathfrak{S}_n . We shall use the notation $\mu \vdash n$, to denote that μ is a partition of n , since the conjugacy class \mathfrak{C}_μ is the set of all permutations on \mathfrak{S}_n with cycle type μ . We may also write λ in terms of the number of times each part of size i appears.

$$\lambda = (1^{m_1}, 2^{m_2}, \dots) = (\underbrace{1, \dots, 1}_{m_1}, \underbrace{2, \dots, 2}_{m_2}, \dots)$$

Throughout, $m_i(\lambda)$, for i greater than zero, denotes the number of occurrences of i as a part in λ , and $\ell(\lambda)$ denotes the **length** of the partition, namely, the number of non-zero parts of λ .

1.2.2 Representations

In investigating the combinatorial nature of the immanant, it is also useful to consider an algebraic approach to this topic. This is assisted by the use of the representation theory of the symmetric group. This section outlines key points from representation theory, which will be used in constructions and proofs throughout the thesis. The background definitions appear in [1] and [2].

An **algebra** is a vector space over a field F with multiplication defined. If F is a field and G is a finite group, then the **Group Algebra** $F[G]$ is $\{\sum_{g \in G} \lambda_g g : \lambda_g \in F\}$. Let R be a ring with identity. Then an **R-Module**, ${}_R M$ is a finite dimensional vector space with an R action.

Let $GL(V)$ be the group of invertible linear maps from a vector space to itself. A **representation** of a finite group G is a group homomorphism $\psi : G \rightarrow GL(V)$ where V is a complex vector space. A representation is irreducible if it does not have any non-trivial subrepresentations. A module ${}_R M$ is **irreducible** or **simple** if it has exactly two submodules, $\{\emptyset\}$ and M .

When considering the algebraic properties of the immanant, it is essential to consider modules in terms of submodules. We describe some general properties of modules that will be assumed to hold throughout this thesis. A module has a **composition series** if there is a chain of submodules $(0) \supset M_0 \supset M_1 \supset \dots \supset M_p = M$ where the quotient of the modules M_{i+1}/M_i is a simple module.

Theorem 1. (Maschke's Theorem). [2] *Every representation of a finite group having positive dimension, can be written as a direct sum of irreducible modules.*

For proofs see [2] or [32]. Specht Modules are the irreducible representations of the symmetric group and we discuss them here. We will use Specht modules when we talk about recursions and the branching rule in Chapter 3.

Let λ be a partition of n . We define a **tabloid**, t , as a filling of a Ferrers diagram with entries $1, \dots, n$ where there is no set ordering of the row entries. The symmetric group acts on tabloids by permuting the entries. This action extends to a vector space, which we denote as V^λ , with the set of tabloids of shape λ as the basis elements. This then forms an irreducible representation of \mathfrak{S}_n over fields with characteristic zero.

If $\lambda \vdash n$, then we define

$$e_t := \sum_{\sigma} \text{sgn}(\sigma) \sigma(t)$$

where t is a tabloid of shape λ and the sum is over permutations σ that fix the columns of t . Note the action $\sigma(e_t) = e_{\sigma(t)}$. We define the **Specht Module**, S^λ to be the subspace of V^λ which is spanned by the function e_t .

1.2.3 Group Characters

The **character** of a module M is a function $\chi^M : A \rightarrow \mathbb{C}$, where χ^M is the trace of the linear transformation determined by the action of an element $a \in A$ on M . For the symmetric group, characters index the set of partitions of $[n]$ of shape λ being acted on by the conjugacy class of the permutation σ . We denote by k_μ the size of a conjugacy class for a partition μ . The character is a class function, meaning that the character is constant across a conjugacy class. Thus, the value of the character of S^λ is χ^λ at $\pi \in \mathfrak{C}_\mu$ for the conjugacy class of \mathfrak{S}_n indexed by $\mu \vdash n$, may be denoted by χ_μ^λ .

We now give a brief definition of restrictions and induced representations on characters. This will be useful in determining how we can write symmetric groups and irreducible characters of the symmetric group, respectively, in terms of smaller groups or characters. This will be used in Chapter 3 to establish a recursive formula for the immanant and in Chapter 4 to use these recursive structures for a combinatorial interpretation.

Definition 1. [32] *Let $H \leq G$ be a subgroup of G and let X be a representation of G . The **restriction** of X to H , $X \downarrow_H^G$, is given by*

$$X \downarrow_H^G = X(h)$$

for all $h \in H$. If the character of X is χ , then the character of $X \downarrow_H^G$ is $\chi \downarrow_H^G$. It is common to write $\chi \downarrow_H$ if the group G is implied.

Definition 2. [32] *Let $G \leq H$ and consider $t_1, \dots, t_l \in G$ such that, $G = t_1H \uplus \dots \uplus t_lH$, where \uplus denotes the disjoint union. If Y is a representation of H then the **induced representation** $Y \uparrow_H^G$ assigns to each $g \in G$ the block matrix*

$$Y \downarrow_H^G(g) = (Y(t_i^{-1}gt_j)) = \begin{pmatrix} Y(t_1^{-1}gt_1) & Y(t_1^{-1}gt_2) & \dots & Y(t_1^{-1}gt_l) \\ Y(t_2^{-1}gt_1) & Y(t_2^{-1}gt_2) & \dots & Y(t_2^{-1}gt_l) \\ \vdots & \vdots & \ddots & \vdots \\ Y(t_l^{-1}gt_1) & Y(t_l^{-1}gt_2) & \dots & Y(t_l^{-1}gt_l) \end{pmatrix}$$

where $Y(g)$ is the zero matrix if $g \notin H$.

Here we write the induced character $\chi \uparrow_H^G$ as the induction of a character from H to G .

1.3 Young Tableaux

This section introduces Ferrers diagrams, a combinatorially convenient way of representing partitions. In addition, we present Young Tableaux, the hook-length formula, and the

Murnaghan-Nakayama Rule. The following definitions may be found in [32] and [11].

Two partitions are **lexicographically ordered** with $\alpha <_{\text{lex}} \beta$ for $\alpha = (\alpha_1, \alpha_2, \dots)$ and $\beta = (\beta_1, \beta_2, \dots)$ with $\alpha_i < \beta_i$, where i is the smallest index such that $\alpha_i \neq \beta_i$. From this we can establish a **lexicographic ordering** for the set of partitions of size n . For example if $n = 5$ we have:

$$(1, 1, 1, 1, 1) <_{\text{lex}} (2, 1, 1, 1) <_{\text{lex}} (3, 1, 1) <_{\text{lex}} (2, 2, 1) <_{\text{lex}} (4, 1) <_{\text{lex}} (3, 2) <_{\text{lex}} (5).$$

1.3.1 Ferrers Diagrams and Young Tableaux

Definition 3 (Ferrers Diagram). A **Ferrers diagram** is a representation of a partition by a list of rows of unit boxes in weakly descending order of length, with the rows justified to the left. We call an individual unit box of a Ferrers diagram a **cell**.

The **conjugate** of a partition, denoted by λ' , consists of columns of unit boxes, weakly decreasing from left to right, with columns justified to the top. We can also obtain the conjugate of a partition from λ , by reflecting the Ferrers diagram of λ along the main diagonal to obtain the Ferrers diagram for λ' . We provide an example for clarification.

Example 1: The following represents the partition $(\lambda_1, \lambda_2, \lambda_3, \lambda_4) = (3, 3, 2, 1)$. Here $\ell(\lambda) = 4$ and $|\lambda| = 9$. The second tableau is that of the conjugate partition, $\lambda' = (4, 3, 2)$. The dashed line marks the main diagonal of the diagram.

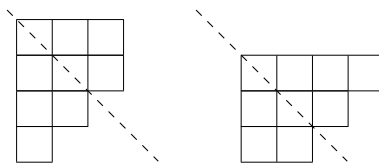

Figure 1.1: A Ferrers Diagram $(3,3,2,1)$ and its conjugate $(4,3,2)$.

Definition 4 (Young Tableaux). A **Semistandard Young Tableau (SSYT)** is an assignment of positive integers to the cells of a Ferrers diagram such that the numbers are non-decreasing along the rows and strictly increasing down the columns. A **Standard Young Tableau (SYT)** is a SSYT with entries $1, \dots, n$, occurring once and once only, where n is the number of cells.

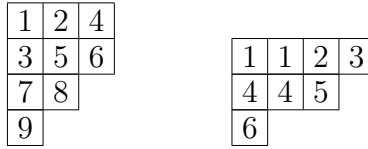

Figure 1.2: A Standard Young Tableau and a Semistandard Young Tableau with $n = 9$.

The **weight** of a tableau, T , is the sequence of positive integers $\nu = (\nu_1, \nu_2, \dots, \nu_n)$ where ν_i denotes the number of times i appears in T . The **content** of a tableau T is a partition λ_T where

$$\lambda_T = (1^{m_1(T)}, 2^{m_2(T)}, \dots) = (\underbrace{1, \dots, 1}_{m_1(T)}, \underbrace{2, \dots, 2}_{m_2(T)}, \dots)$$

where $m_i(T)$ is the number of occurrences of i in T .

We define a **subtableau** μ of a tableau λ to be a tableau with the same top-left-corner that is geometrically contained in λ . The **difference** of the tableaux λ, μ , is the operation of deleting μ from λ , where μ is a subtableau of λ . The tableau obtained by taking the difference of λ and μ is the **skew** tableau, denoted by λ/μ . A skew diagram is said to be **connected**, if it is possible to move from an arbitrary cell to any other cell by a sequence of horizontal and vertical steps, without leaving the tableau.



Figure 1.3: A skew tableau with $\lambda = (5, 4, 3)$ and $\mu = (3, 2)$.

1.3.2 Littlewood-Richardson Coefficient

We shall also discuss the Littlewood-Richardson Rule which will later be used in the decomposition of characters into certain constituents. This will be used in Chapter 3 for determining recursive formulae for the immanant. We first have the following necessary definitions.

We define the **row word** of a tableau T to be the permutation obtained by reading the

rows of the tableau from left to right, starting with the last row moving upwards. For example, if we have the following tableau the row word is 564461223.

1	2	2	3
4	4	6	
5	6		

Definition 5 (Lattice Permutation). [32] *A **lattice permutation** is a sequence of positive integers, $\pi = i_1 i_2 \dots i_n$ such that, for any initial substring $\pi_k = i_1 i_2 \dots i_k$ with $k \leq n$, the number of times the positive integer m appears is at least as large as the number of times $(m + 1)$ appears.*

For example,

$$\pi = 1123213$$

is a lattice permutation, while

$$\pi = 1232313$$

is not as the string 1232 has a greater number of twos than ones. We can now state the following definition.

Definition 6 (The Littlewood-Richardson Coefficient). [32] *The **Littlewood-Richardson coefficient**, $c_{\mu\nu}^\lambda$, is equal to the number of semistandard tableaux T such that,*

- (i) T has shape λ/μ and weight ν ,
- (ii) the row word of T is a reverse lattice permutation.

1.3.3 Hooks

This section discusses certain tableaux that have useful combinatorial properties that will be used in later constructions in Chapters 3 and 4. In addition, we discuss previous interpretations for the immanant indexed by a hook tableau from Clearman, Shelton, and Skandera [8], in Chapter 2.

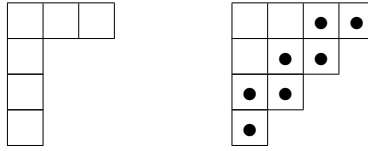

Figure 1.4: A Hook and a rim hook

Definition 7 (Hooks and Rim Hooks). A **hook** is a partition of n such that, $\lambda = (k, 1^{n-k})$, for some positive integer $k \leq n$. A **rim hook** or a **ribbon** is a connected skew tableau that contains no 2×2 boxes.

Now that we have established the definition of a hook, we can discuss the hook-length of a tableau, which may be used to compute the number of SYT shape λ . Let f^λ denote the number of standard Young tableaux of shape λ . We then have the following concepts.

Definition 8 (Hook-length). The **hook-length** of a cell, $h_{i,j}$, in a partition λ , is the number of squares directly below or to the right of (i, j) , including (i, j) itself.

For example, if $\lambda = (5^2, 4, 3, 1)$ the hook-length of $(2,3)$ is $h_{2,3} = 5$.

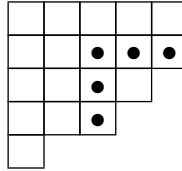

Figure 1.5: The Hook-length $h_{2,3}$ of the cell $(2, 3)$ in a tableau.

Theorem 2. (The Hook-length Formula).[32]

If λ is a partition of n , then

$$f^\lambda = \frac{n!}{\prod_{(i,j) \in \lambda} h_{i,j}},$$

where $h_{i,j}$ denotes the hook-length of cell (i, j) in the tableau and the product is over all cells (i, j) in the tableau of shape λ .

We now discuss the Murnaghan-Nakayama Rule, which provides a means for calculating group characters recursively using rim hooks. This will be an important tool when we consider recursive formulations for the immanant in Chapter 3.

Theorem 3. (Murnaghan-Nakayama Rule). [32]

Let $\lambda \vdash n$ and $\alpha = (\alpha_1, \dots, \alpha_k)$ be a partition of n , then

$$\chi_\alpha^\lambda = \sum_{\xi} (-1)^{ll(\xi)} \chi_{\alpha \setminus \alpha_i}^{\lambda \setminus \xi}.$$

The summation runs over all rim hooks, ξ , of λ having α_i cells, and $ll(\xi)$, the leg length, denotes the number of rows of ξ minus 1.

The Murnaghan-Nakayama Rule provides a convenient way of computing characters recursively. In general, there are no closed formulae for evaluating the irreducible characters of \mathfrak{S}_n . This recursive formulation allows us to consider characters in terms of smaller partitions, so we can compute group characters based on partitions that have simpler computations. The Murnaghan-Nakayama Rule is used in several constructions in Chapter 2, as well as in the recursive formulations in Chapter 3.

We now state a theorem that will be used in proofs in Chapter 2 of this thesis.

Theorem 4. (Principle of Inclusion-Exclusion). [32]

Let f, g be functions from the set of all subsets $S \subseteq \{1, \dots, n\}$ to a vector space. Then:

$$f(S) = \sum_{T \subseteq S} g(T), \text{ for all } S \subseteq \{1, \dots, n\},$$

if and only if,

$$g(S) = \sum_{T \subseteq S} (-1)^{|T|-|S|} f(T), \text{ for all } S \subseteq \{1, \dots, n\}.$$

1.4 Symmetric Functions

In order to apply an algebraic approach to interpretations of the immanant, it is essential to use symmetric functions. For completeness, the definitions of the symmetric functions are given, together with the properties that are used in this thesis. The following definitions are from [32].

Definition 9 (Symmetric Functions). A function, f , in indeterminates x_1, x_2, \dots , is a **symmetric function** if:

- (i) $f(x_1, x_2, \dots)$ is a sum of monomials, such that the degree of f is bounded and,
- (ii) $f(x_{\pi(1)}, x_{\pi(2)}, \dots) = f(x_1, x_2, \dots)$ for all permutations, π , that move a finite number of elements of $(1, 2, \dots)$.

We denote the symmetric group on n indeterminates (x_1, \dots, x_n) as \mathfrak{S}_n . We denote, $[x^k]f(x)$, to be the coefficient operator, which denotes the coefficient of x^k in the polynomial $f(x)$.

We can define $\Lambda^{(n)}(x) = \mathbb{Q}[x_1, \dots, x_n]^{\mathfrak{S}_n}$ to be the set of all symmetric functions contained in $\mathbb{Q}[x_1, \dots, x_n]$, where \mathbb{Q} denotes the rational numbers. In addition, since the sum and product of symmetric functions is symmetric, $\Lambda^{(n)}(x)$ also forms a ring. The vector space of symmetric functions can be defined as follows

$$\Lambda^{(n)}(x) = \bigoplus_{k \geq 0} \Lambda_k^{(n)}(x)$$

where $\Lambda_k^{(n)}(x)$ is the subspace of all homogeneous degree k symmetric polynomials, with each defining a vector space. We now define some of the fundamental symmetric functions that will be used throughout this thesis.

Definition 10 (Power Sum Symmetric Functions). *For a finite number of indeterminates, x_1, x_2, \dots, x_n ,*

$$p_k(x_1, \dots, x_n) := \begin{cases} n & \text{if } k = 0, \\ x_1^k + \dots + x_n^k & \text{otherwise} \end{cases}$$

*is the **power sum symmetric function** of degree k .*

Definition 11 (Elementary Symmetric Functions). *For a finite number of indeterminates, x_1, x_2, \dots, x_n ,*

$$e_k(x_1, \dots, x_n) := \begin{cases} 1 & \text{if } k = 0, \\ \sum_{1 \leq i_1 < \dots < i_k \leq n} x_{i_1} \dots x_{i_k} & \text{otherwise} \end{cases}$$

*is the **elementary symmetric function** of degree k .*

Note for a partition $\lambda = (\lambda_1, \dots, \lambda_k)$, these definitions extend multiplicatively through the partition.

$$p_\lambda := p_{\lambda_1} p_{\lambda_2} \dots p_{\lambda_k} \quad \text{and} \quad e_\lambda := e_{\lambda_1} e_{\lambda_2} \dots e_{\lambda_k}.$$

Given a partition, $\lambda = (\lambda_1, \lambda_2, \dots)$, we can define the monomial $x^\lambda := x^{\lambda_1} x^{\lambda_2} \dots$, as λ has only finitely many parts. This then leads to the definition of the monomial symmetric functions.

Definition 12 (Monomial Symmetric Functions).

$$m_\lambda := \begin{cases} 1 & \text{if } \lambda \text{ is empty,} \\ \sum_{\pi} \pi(x^\lambda) & \text{otherwise} \end{cases}$$

is the **monomial symmetric function**. Where the sum is over all permutations $\pi \in \mathfrak{S}_n$ that give distinct images of x^λ .

Equivalently, we can consider the elementary symmetric functions and the power sum symmetric functions in terms of the monomial symmetric functions.

$$e_k = \begin{cases} 1 & \text{if } k = 0, \\ m_{[1^k]} & \text{if } k > 0. \end{cases}$$

$$p_k = \begin{cases} 1 & \text{if } k = 0, \\ m_{(k)} & \text{if } k > 0. \end{cases}$$

Definition 13 (Complete Homogeneous Symmetric Functions).

$$h_k := \sum_{1 \leq i_1 \leq \dots \leq i_k} x_{i_1} x_{i_2} \dots$$

is the **homogeneous symmetric function**.

It follows that the homogeneous symmetric functions can also be expressed in terms of the monomial symmetric functions, by

$$h_k = \begin{cases} 1 & \text{if } k = 0, \\ \sum_{\lambda \vdash k} m_\lambda & \text{if } k > 0. \end{cases}$$

Definition 14 (Schur Functions). *The Schur functions are the symmetric functions defined as the generating function for all SSYT of shape λ weighted by their content.*

$$s_\lambda := \sum_{T \in \text{SSYT}(\lambda)} x_1^{c_1(T)} x_2^{c_2(T)} \dots$$

Although it takes some work to show that this in fact defines a symmetric function, we refer the reader to [8] for the formal argument. A useful property that we can deduce from

the definition of Schur functions allows us to consider characters of the symmetric group in terms of Schur functions,

$$\chi_\mu^\lambda = \frac{k_\mu}{n!} [p_\mu] s_\lambda,$$

where k_μ is the size of conjugacy class of μ and $[p_\mu]$ is the coefficient operator of the power sum symmetric functions.

We shall have occasion to make use of the cycle index polynomial of \mathfrak{S}_n . This is defined as follows. For a partition $\lambda = (1^{m_1}, 2^{m_2}, \dots, n^{m_n})$ with $\sigma \in \mathfrak{S}_n$ having type λ , let

$$z_\lambda := 1^{m_1} m_1! 2^{m_2} m_2! \cdots n^{m_n} m_n!$$

Then

$$Z_{\mathfrak{S}_n} := \frac{1}{n!} \sum_{\lambda \vdash n} \frac{n!}{z_\lambda} p_1^{m_1(\lambda)} p_2^{m_2(\lambda)} \cdots$$

is the cycle index polynomial of \mathfrak{S}_n . That is, it is the generating series for all permutations with respect to cycle type, with each i -cycle marked by a p_i and normalized by the order of the group.

For example,

$$Z_{\mathfrak{S}_3} = \frac{1}{6} (p_1^3 + 3p_1 p_2 + 2p_3).$$

Theorem 5. (Bases of the Ring of Symmetric Functions).[32]

The following are bases for Λ_n : $\{m_\lambda | \lambda \vdash n\}$, $\{s_\lambda | \lambda \vdash n\}$, $\{e_\lambda | \lambda \vdash n\}$, $\{h_\lambda | \lambda \vdash n\}$, and $\{p_\lambda | \lambda \vdash n\}$.

We can also perform operations with our bases of \mathfrak{S}_n . We detail the convenient inner product that will be used in computations throughout this thesis.

Definition 15 (The Hall Inner Product). *We can define the inner product $\langle \cdot, \cdot \rangle$ on $\Lambda^{(d)}$ such that for bases $\{u_\lambda\}$ and $\{v_\mu\}$:*

$$(i) \quad \langle u_\lambda, v_\mu \rangle = \delta_{\lambda, \mu},$$

$$(ii) \sum_{\lambda} u_{\lambda}(x)v_{\mu}(y) = \prod_{i,j \geq 1} (1 - x_i y_j)^{-1},$$

where $\delta_{\lambda,\mu}$ is the Delta function defined by:

$$\delta_{\lambda,\mu} = \begin{cases} 1 & \text{if } \lambda = \mu, \\ 0 & \text{otherwise.} \end{cases}$$

Definition 16 (Dual Bases of the Ring of Symmetric Functions). *We have several relationships between the bases of the symmetric function. Some examples of dual bases are:*

- (i) *The monomial symmetric functions, $\{m_{\lambda} : \lambda \vdash n\}$, are dual with the homogeneous symmetric functions, $\{h_{\lambda} : \lambda \vdash n\}$, with respect to this inner product.*
- (ii) *The Schur functions, $\{s_{\lambda} : \lambda \vdash n\}$, are self-dual and form an orthonormal basis of $\Lambda^{(n)}$.*
- (iii) *The power sum symmetric functions, $\{p_{\lambda} : \lambda \vdash n\}$, are dual with the power sum symmetric functions normalized by z_{λ} , and form an orthogonal basis of $\Lambda^{(n)}$.*

1.4.1 Jacobi-Trudi

The Jacobi-Trudi formula expresses the Schur functions in terms of the complete and elementary symmetric functions. We introduce this identity, as well as Jacobi-Trudi matrices, which play a key role in combinatorial interpretations of the determinant and the positivity of the immanant in Chapter 2.

Theorem 6. (The Jacobi-Trudi Identity). [32]

Let $\lambda = (\lambda_1, \dots, \lambda_m)$ be a partition of n with m parts. Then:

$$s_{\lambda} = \det(h_{\lambda_i - i + j})_{i,j=1,\dots,m},$$

and

$$s_{\lambda'} = \det(e_{\lambda_i - i + j})_{i,j=1,\dots,m}.$$

The Jacobi-Trudi Matrix is defined by

$$H(\nu, \mu) := (h_{(\nu_i - i) - (\mu_j - j)})_{i,j=1,\dots,n}.$$

In particular,

$$\det(H(\nu, \emptyset)) = s_{\nu}.$$

1.5 Immanants of Symmetric Functions

This thesis provides a systematic approach to combinatorial interpretations for the immanant. This section presents the general definition of the immanant, as well as various specializations of the function, that are used throughout this thesis.

Let $M_n(F)$ denote the algebra of $n \times n$ matrices over a field F of characteristic zero, with elements $A = [a_{i,j}]$.

Definition 17 (Immanant). [35] *Let χ^λ be an irreducible character of \mathfrak{S}_n . Then the **immanant** indexed by the partition λ , is the polynomial in the elements of $A \in M_n(F)$ defined as follows:*

$$\text{Imm}_\lambda(A) := \sum_{\sigma \in \mathfrak{S}_n} \chi^\lambda(\sigma) a_{1,\sigma(1)}, \dots, a_{n,\sigma(n)}, \text{ where } A \in M_n(F).$$

It is immediate that,

$$\begin{aligned} \text{Per}(A) &= \text{Imm}_{(n)}(A) \\ \det(A) &= \text{Imm}_{(1^n)}(A) \end{aligned}$$

since for partitions $[n]$ and $[1^n]$,

$$\begin{aligned} \chi_\mu^{(n)} &= 1 \text{ and,} \\ \chi_\mu^{(1^n)} &= \text{sgn}(\sigma), \text{ for } \sigma \in \mathfrak{C}_\mu. \end{aligned}$$

Here $\text{sgn}(\sigma) = (-1)^m$, is called the **signum** of σ , where m denotes the number of transpositions in a decomposition of the permutation into a product of transpositions. This decomposition is not unique but the parity is constant for each transposition. We use this definition of the **parity** of a permutation as it becomes useful in later constructions. A permutation, σ , is **even** if $\text{sgn}(\sigma) = 1$ and is **odd** if $\text{sgn}(\sigma) = -1$.

In the notation of Definition 17, the permanent function and the determinant function, written explicitly, are

$$\begin{aligned} \text{Per}(A) &:= \sum_{\sigma \in \mathfrak{S}_n} \prod_{i=1}^n a_{i,\sigma(i)}, \text{ where } A \in M_n(F). \\ \det(A) &:= \sum_{\sigma \in \mathfrak{S}_n} \text{sgn}(\sigma) \prod_{i=1}^n a_{i,\sigma(i)}, \text{ where } A \in M_n(F). \end{aligned}$$

These are two specializations of the immanant that have been used to form combinatorial interpretations, which we present in Chapter 2.

We now define two special cases of the immanant for certain classes of symmetric functions. In order to do this we must describe the Frobenius characteristic map.

Definition 18 (Frobenius Characteristic Map). [12] *Let R^n denote the space of class functions on \mathfrak{S}_n and let $R = \sum_{n \geq 0} R^n$. We have a basis of irreducible characters for R , and define multiplication to be the tensor product. The **Frobenius characteristic map** is defined by $\text{ch} : R \rightarrow \Lambda$, with*

$$\text{ch}(\chi) = \frac{1}{n!} \sum_{|\mu|=n} k_\mu \chi_\mu p_\mu$$

where χ_μ is the value of χ on the class corresponding to μ .

Thus, $\text{ch}(\chi^\lambda) = s_\lambda$.

We now augment the types of immanants we already have, namely $\text{Imm}(A)$ and $\text{Imm}_\lambda(A)$, by a further two that involve the monomial and elementary symmetric functions. The combinatorial interpretations for these immanants are discussed in Chapter 2.

Definition 19 (Monomial Immanant). *If $\lambda \vdash n$, then ϕ^λ is the \mathfrak{S}_n class function associated with the Frobenius characteristic map to the monomial symmetric function m_λ*

$$m_\lambda = \frac{1}{n!} \sum_{\sigma \in \mathfrak{S}_n} \phi^\lambda(\sigma) p_{\rho(\sigma)}.$$

The **monomial immanant** is then defined as follows:

$$\text{Imm}_{\phi^\lambda}(A) := \sum_{\sigma \in \mathfrak{S}_n} \phi^\lambda(\sigma) a_{1,\sigma(1)} \cdots a_{n,\sigma(n)}, \text{ where } A \in M_n(F).$$

Definition 20 (Elementary Immanant). *If $\lambda \vdash n$, then ϵ^λ is the \mathfrak{S}_n class function associated with the Frobenius characteristic map to the elementary symmetric function e_λ :*

$$e_\lambda = \frac{1}{n!} \sum_{\sigma \in \mathfrak{S}_n} \epsilon^\lambda(\sigma) p_{\rho(\sigma)}.$$

The **elementary immanant** is then defined as follows:

$$\text{Imm}_{\epsilon^\lambda}(A) := \sum_{\sigma \in \mathfrak{S}_n} \epsilon^\lambda(\sigma) a_{1,\sigma(1)} \cdots a_{n,\sigma(n)}, \text{ where } A \in M_n(F).$$

1.6 Graph Theory

Several of the combinatorial interpretations of the immanant and its restrictions presented here use constructions from graph theory. We therefore provide a brief introduction to some graph theoretical concepts which will be used in the literature review in Chapter 2, as well as in the constructions in Chapter 4. The following definitions appear in [10].

A **graph**, $G = (V, E)$, is a pair of sets of vertices and edges, where the edges are subsets of the vertices. We exclude loops in graphs throughout this thesis, therefore an edge is a two element subset of the vertex set of a graph. If $G' = (V', E')$ such that $V' \subseteq V$ and $E' \subseteq E$, then G' is a **subgraph** of G . Additionally, the weight of a subgraph, $G' \in G$, is the product of the weight of the edges of G' . The following graph-theoretic definitions will be used throughout this thesis.

- (i) The **degree** of a vertex is the number of edges that are incident to that vertex. We denote this $deg(v)$.
- (ii) A **directed graph** is a pair (V, E) with two maps $I : E \rightarrow V$ and $T : E \rightarrow V$ assigning each edge an initial and terminal vertex. Edges are directed from the initial vertex to the terminal vertex with an arrow.
- (iii) A **multigraph** is a graph that may have multiple edges with the same endpoints. Therefore there may be several edges going from a vertex u to a vertex v .
- (iv) In a directed graph, the **in-degree** of a vertex is the number of edges directed into the vertex and the **out-degree** is the number of edges directed away from the vertex. We refer to a vertex with in-degree 0 as a **source** and a vertex with out-degree 0 as a **sink**.
- (v) A **path** is a non-empty graph, $P = (V, E)$, of the form
$$V = \{x_0, x_1, \dots, x_k\}, \quad E = \{x_0x_1, x_1x_2, \dots, x_{k-1}x_k\}.$$
- (vi) A **cycle** is a closed path, or a path in which the endpoints are joined by an edge. We call a graph **acyclic** if it contains no cycles.
- (vii) A graph is **connected** if it is possible to form a path between any vertex and any other vertex in G .
- (viii) A **directed acyclic graph** is a directed graph that contains no directed cycles.

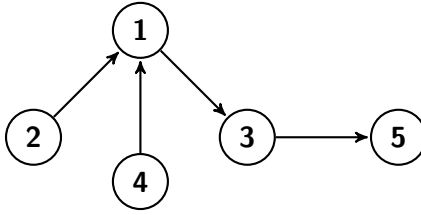

Figure 1.6: A directed acyclic graph G .

- (ix) A graph is **weighted** if we associate a **weight** to every edge in the graph using a weight function $\text{wt}(e)$. For our purposes weighted graphs throughout this thesis will have positive integer weights. A directed weighted graph may also be referred to as a **network**.
- (x) A **planar** graph, is a graph that can be embedded in the plane. In other words, the graph can be drawn so that no edges cross each other.

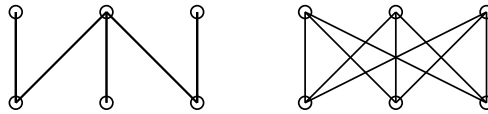

Figure 1.7: A planar graph and a non-planar graph.

- (xi) A **tree** is a connected, acyclic graph, with $n - 1$ edges on n vertices. An **indirected tree** is a tree with a root at vertex, v , such that all edges of the graph are directed toward v .

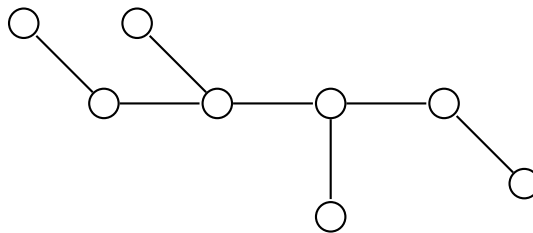

Figure 1.8: A tree.

In addition, some subsets of a graph are of importance in certain combinatorial interpretations of irreducible character immanants. The following definition is used in the interpretation of the permanent in Chapter 2.

Definition 21 (Cycle Covers). Let $G(V, E, wt)$ be a directed, weighted graph. A **cycle cover**, C , is a subset of the edges that forms a set of vertex-disjoint directed cycles such that each vertex is contained in at least one cycle.

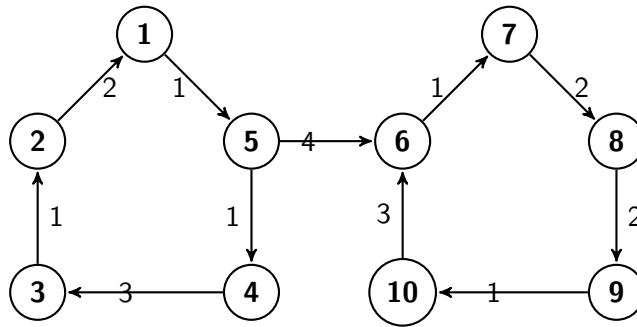

Figure 1.9: A connected weighted graph G with cycle cover $\{(5, 4, 3, 2, 1), (6, 7, 8, 9, 10)\}$

The following definition will be used in the discussion of the complexity of the immanant in the next section.

Definition 22 (Hamiltonian Cycle). A **Hamiltonian cycle** is a cycle in an undirected graph that visits each vertex exactly once. The **Hamiltonian cycle problem** is the problem of determining whether a particular graph contains any Hamiltonian cycles.

We also discuss the Matrix Tree Theorem which will be used in the discussion of previous combinatorial interpretations of the immanant in Chapter 2. We present the version from [36].

Theorem 7. (Matrix Tree Theorem).[36]

The number of spanning trees of a graph, G , is equal to any principal cofactor of the degree matrix of G minus the adjacency matrix of G .

The **adjacency matrix** is the binary matrix with a 1 in position $a_{i,j}$ if (i, j) is an edge in the graph and 0 if (i, j) is not an edge in the graph. Since the graphs are loopless, the adjacency matrices have zero diagonals.

The **degree matrix** is the diagonal matrix, $D = \text{diag}(deg(1), \dots, deg(n))$, where $deg(1), \dots, deg(n)$ denotes the degree of each vertex for $i = 1, \dots, n$ in the graph.

1.7 Complexity of Computing Immanants

The two main complexity classes of algorithms are P and NP. These two classes distinguish between problems which have an algorithm that is solvable in polynomial time, which are classified as P, and problems which can be verified in polynomial time, classified as NP. Valiant [37] introduced the two classes VP and VNP which correspond to an algebraic analogue for P and NP. We provide a brief overview of the classes VP and VNP and then discuss the complexity of the immanant. We begin with some motivating definitions from [28].

An **arithmetic circuit** is a finite directed acyclic graph with vertices of in-degree 0 or 2, and exactly one vertex of out-degree 0. We classify vertices in the following way:

- (i) Vertices of in-degree 0 are called **inputs**.
- (ii) Vertices of in-degree 2 are called **computation gates**, and are labelled by + or \times .
- (iii) The vertex of out-degree 0 is called the **output**.
- (iv) The vertices are called **gates** and edges are called **arrows**.

We provide an example for clarification. These circuits are an integral part of the definition of VP and VNP and we discuss some of the necessary properties for classifying these circuits. The **size** of the circuit is defined to be the number of gates, while the **depth** is the maximum length of the directed paths from an input to the output. We define the **degree** of a gate $d(v)$ to be

$$d(v) := \begin{cases} 1 & \text{if } v \text{ is an input,} \\ \text{Max of incoming degrees} & \text{if } v \text{ is a } + \text{ gate,} \\ \text{Sum of incoming degrees} & \text{if } v \text{ is a } \times \text{ gate.} \end{cases}$$

The degree of the circuit is the degree of the output gate. We are now ready to state the formal definitions of VP and VNP.

Definition 23. [28] *A sequence of polynomials $\{f_1, \dots, f_n\}$ in x is in the class VP, if there exists a sequence of circuits $\{C_1, \dots, C_n\}$ of polynomially bounded size and degree, such that $\{C_1, \dots, C_n\}$ represents $\{f_1, \dots, f_n\}$.*

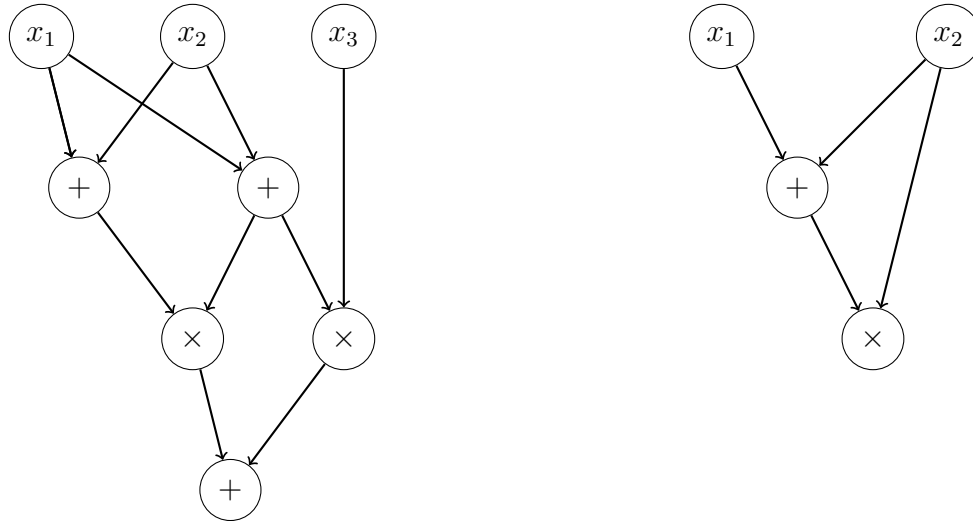

Figure 1.10: An example of arithmetic circuits with the x_i denoting the inputs.

A sequence of polynomials $\{f_1, \dots, f_n\}$ is in the class VNP if there exists a polynomial p and a sequence $g_n \in \text{VP}$ such that

$$f_n(x) = \sum_{\epsilon \in \{0,1\}^{p(|x|)}} g_n(x, \epsilon).$$

The determinant has been shown to be calculated in polynomial time using Gaussian elimination [5]. However, Valiant [37] showed the permanent is VNP-Complete, where VNP denotes Valiant's algebraic equivalent of NP-completeness for computations with univariate polynomials over a field [5].

In a similar fashion, Brylinski and Brylinski [4] demonstrated that computing the immanant is VNP-Complete and that analogous results hold when computing the immanant indexed by a hook or rectangular tableau. The complexity of these immanants may be deduced using the Hamiltonian Path Problem, as in [5]. We give a brief description of their construction.

Suppose we wish to count the Hamiltonian cycles in a graph with adjacency matrix A . Using the formulation from [4], the number of Hamiltonian cycles is

$$\sum_{\sigma \in \mathfrak{S}_n} f(\sigma) \prod_{i=1}^n a_{i, \sigma(i)}$$

where

$$f(\sigma) := \begin{cases} 1 & \text{if } \sigma \text{ is an } n\text{-cycle,} \\ 0 & \text{otherwise.} \end{cases}$$

From this formulation, since f is a class function, the solution may be obtained by using a linear combination of irreducible characters of the symmetric group and is therefore expressible as a linear combination of immanants. Since the Hamiltonian Path Problem is NP-Complete, computing the immanant must be NP-Complete as well. For full details see [5].

1.8 Positivity of Matrices and Immanants

One of the main areas of research involving the immanant concerns the positivity of the immanant of a totally nonnegative matrices. While there has been much progress on this topic, there are still several open problems including finding an informative combinatorial interpretation. We begin with some preliminary definitions on the positivity of matrices and polynomials.

A matrix A is **Totally Nonnegative (TNN)** if the determinant of all matrix minors is nonnegative. A polynomial $p(x) \in \mathbb{C}[x_{1,1}, \dots, x_{n,n}]$ is TNN if for an $n \times n$ matrix $A = (a_{i,j})$, where A is TNN

$$p(A) := p(a_{1,1}, a_{2,2}, \dots, a_{n,n}) \geq 0.$$

A symmetric function is **Monomial Nonnegative (MNN)** or **Schur Nonnegative (SNN)** if its expansion in the monomial basis or the Schur basis, respectively, has nonnegative coefficients. A polynomial is MNN or SNN, if for each Jacobi-Trudi matrix $H(\nu, \mu)$, the polynomial $p(H(\nu, \mu))$ is MNN or SNN, respectively.

Graph theoretic interpretations for the determinant of a TNN matrix were given by Karlin and McGregor [22] and Lindström [25]. In addition, Goulden and Jackson [14] introduced conjectures on the positivity of the immanant which were later proved by Stembridge [35]. The irreducible character immanants have been shown to be TNN and MNN although analogous results have not been achieved for the case of SNN. In addition, these results have no corresponding combinatorial interpretation analogous to that of the determinant.

In this thesis, we present some of these positivity results including Greene [18] for the coefficients of the immanant of the Jacobi-Trudi matrix. In addition, Clearman, Shelton, and Skandera [8], present results for the positivity of the immanant on TNN matrices, for the elementary and monomial immanants.

1.9 Supporting Computer Programs

Two Maple packages, *Immanants* and *PlanarNetworks*, were written to provide data in which regularities, patterns, and in principle combinatorial interpretations may be inferred. The first package uses the symmetric function and group theory packages in Maple to generate immanants for specific matrices for a partition indexing the irreducible representation χ^λ . The *PlanarNetworks* package generates a random number of vertices and edges and creates a planar network to be used for immanant computations. Sample Maple code is given in Appendix A.

1.10 Outline

This thesis is organized as follows: In Chapter 2, we present some previous combinatorial interpretations for the immanant and its special cases mentioned earlier, the determinant and permanent. We shall describe a graph theoretic interpretation for the permanent of binary matrices, as well as an interpretation for the permanent by Ben-Dor and Halevi [3] using cycle covers of directed graphs. We then present the combinatorial interpretation for the determinant by Gessel, Viennot, and Lindström.

We next present some preliminary combinatorial interpretations for the immanant. We begin with the interpretation by Greene [18] for Jacobi-Trudi matrices. Next, we consider the interpretation by Goulden and Jackson [15] for matrices involved in the Matrix Tree Theorem. We then introduce the Temperley-Lieb algebra and some interpretations of elementary immanants using colourings of the elements of this algebra. This leads to a natural discussion on the interpretation by Clearman, Shelton, and Skandera [8] for hook partitions. We present the concepts of R -weighted planar networks for a ring R , and path tableaux which provides a background for further interpretations in Chapter 4.

In Chapter 3, we present some recursive structures for the symmetric group and for the irreducible characters of the symmetric group. We then use these recursive constructions

to derive recursive formulae for the immanant for specific irreducible characters of the symmetric group in Chapter 3. We then present a general recursive formula for the immanant and introduce the concept of a weighted immanant. These recursive structures will then be used in Chapter 4 to extend the combinatorial interpretations from Chapter 2.

Chapter 4 extends the results of Chapter 2 for combinatorial interpretations of the immanant. We begin with a combinatorial interpretation for the immanant on certain classes of matrices. We then present a variation of the combinatorial interpretation for the permanent using the R -weighted planar networks. In addition, we extend the combinatorial interpretation of the permanent of binary matrices to more general cases such as weighted networks.

In addition, we also state a corollary of the Gessel, Viennot, and Lindström interpretation of determinants for planar networks. We present a counterexample that shows the interpretation from Clearman, Shelton, and Skandera [8] cannot be generally extended to all cases of the immanant. In fact, we then show some extensions using the recursive structures from Chapter 3 and provide some conjectures of further combinatorial interpretations which can be made.

Chapter 5 serves as a conclusion and an outline of future extensions for classes of immanants. We make observations based on connections with current interpretations. These have led to the formulation of conjectures for other classes of matrices and immanants indexed by other classes of tableaux. In particular, we discuss the remaining open cases for combinatorial interpretations of the immanant and possible results relating to the positivity of the immanant that are still open problems.

Chapter 2

Previous Combinatorial Interpretations

This thesis is concerned with interpretations of the immanant that are essentially combinatorial in nature. Here we describe a selection of the previous combinatorial interpretations for the immanant and its special cases, the permanent and determinant.

2.1 Combinatorial Interpretations of Permanents and Determinants

There are several previous combinatorial interpretations for the determinant and the permanent. As the permanent and determinant are specializations of the immanant, these interpretations may help to build a more general characterization.

2.1.1 Permanents and Bipartite Graphs

The first interpretation we present is a standard result that is used to interpret the permanent of a binary matrix as a combinatorial object. We present the version from [20].

Theorem 8. (Combinatorial Interpretations of Permanents of Binary Matrices).
Let G be a bipartite graph with bipartitions (X, Y) , such that $|X| = |Y| = n$. Let A be the

binary matrix with entries defined as follows:

$$a_{i,j} := \begin{cases} 1 & \text{if } (x_i, y_j) \text{ is an edge in } G, \\ 0 & \text{otherwise.} \end{cases}$$

Let $M(G)$ denote the set of perfect matchings in G . Then:

$$\text{Per}(A) = |M(G)|.$$

Proof. Consider the subgraph of a bipartite graph corresponding to a permutation, $\sigma \in \mathfrak{S}_n$, $\{(x_i, y_{\sigma(i)}) | i = 1, \dots, n\}$.

Suppose $\{(x_i, y_{\sigma(i)}) | i = 1, \dots, n\}$ is a perfect matching. Then there must be an edge connecting nodes x_i and $y_{\sigma(i)}$ and thus $a_{i,\sigma(i)} = 1$ for all $i \in [n]$. Therefore $\prod_{i=1}^n a_{i,\sigma(i)} = 1$.

Now suppose $\{(x_i, y_{\sigma(i)}) | i = 1, \dots, n\}$ is not a perfect matching. Then there must be some edge between x_j and $y_{\sigma(j)}$ for some $j \in [n]$ that does not appear in the graph, and thus $a_{j,\sigma(j)} = 0$. Therefore $\prod_{i=1}^n a_{i,\sigma(i)} = 0$.

Summing over all permutations, $\sigma \in \mathfrak{S}_n$, we have:

$$\text{Per}(A) = \sum_{\sigma \in \mathfrak{S}_n} \prod_{i=1}^n a_{i,\sigma(i)} = |M(G)|,$$

which concludes the proof. □

2.1.2 Permanents and Cycle Covers

The next interpretation is a modification of the proof for the complexity of the permanent. Ben-Dor and Halevi [3] used cycle covers to simplify the proof of the complexity of the permanent, from Valiant [37].

Theorem 9. (Permanents and Cycle Covers).

Let $G(V, E, \text{wt})$ be a directed weighted graph with $|V| = n$. Let $A \in M_n(F)$, where A is the weighted adjacency matrix of G . Therefore, the entries $a_{i,j} = \text{wt}(i, j)$ where the weight function is the integer weight of the edge i, j in the graph. Let \mathcal{CC} denote the set of all cycle covers of G . Then

$$\text{Per}(A) = \sum_{C \in \mathcal{CC}} \text{wt}(C).$$

Proof. The first task is to establish that each cycle cover in \mathcal{CC} corresponds to a unique permutation.

Consider an arbitrary cycle cover C , with $\text{wt}(C) = g$ for some $g > 0$. Now consider the permutation, $\sigma(i) = j$, if (i, j) is an edge in C . Since all cycles are vertex disjoint and each vertex appears in at least one cycle, there is a bijection on \mathfrak{S}_n . Therefore

$$\prod_{i=1}^n a_{i,\sigma(i)} = \prod_{e \in C} \text{wt}(e) = \text{wt}(C) = g.$$

Therefore, for each cycle cover we can define a permutation σ that is unique to that cycle cover.

Now consider a permutation $\sigma \in \mathfrak{S}_n$ such that $\prod_{i=1}^n a_{i,\sigma(i)} = g$. For $i \in \{1, \dots, n\}$ compute $\{i, \sigma(i), \sigma^2(i), \dots, \sigma^n(i)\}$. By the Pigeonhole Principle, there must be a repetition in the above set. Without loss of generality, assume $\sigma^j(i) = \sigma^k(i)$, with $j \neq k$. Since all weights are nonzero, $\sigma^j(i), \sigma^{j+1}(i), \dots, \sigma^k(i)$ forms a cycle and one can then find cycles for all $i \in V(G)$. Since σ is a permutation, all cycles will be disjoint and the set of cycles will cover the graph. Thus for each permutation with $\prod_{i=1}^n a_{i,\sigma(i)} = g$ we have a cycle cover C . Thus,

$$\prod_{i=1}^n a_{i,\sigma(i)} = \text{wt}(C).$$

Summing over the permutations of \mathfrak{S}_n we have

$$\begin{aligned} \sum_{\sigma \in \mathfrak{S}_n} \prod_{i=1}^n a_{i,\sigma(i)} &= \sum_{\sigma \in \mathfrak{S}_n} \text{wt}(C), \\ &= \sum_{C \in \mathcal{CC}} \text{wt}(C), \end{aligned}$$

which completes the proof. □

2.1.3 Lattice Paths and the Determinant

There are several combinatorial interpretations of the determinant, such as that of Karlin-McGregor [22] and Lindström [25]. Here we present the well-known interpretation by Gessel, Viennot, and Lindström. We begin with a motivating definition of sign-reversing involutions, that is necessary to prove this construction from [17].

Proposition 1. (Sign-reversing bijections).

Let \mathcal{S} be a set with weight function, wt , and let $\mathcal{T} \subseteq \mathcal{S}$. Let σ be a permutation. Suppose there exists a bijection $\alpha : \mathcal{S} \setminus \mathcal{T} \rightarrow \mathcal{S} \setminus \mathcal{T}$ with the properties that $\text{wt}(\sigma) = \text{wt}(\alpha(\sigma))$, and if $\text{sgn}(\sigma) = 1$ then $\text{sgn}(\alpha(\sigma)) = -1$ and if $\text{sgn}(\sigma) = -1$ then $\text{sgn}(\alpha(\sigma)) = 1$. Then,

$$\sum_{\sigma \in \mathcal{S}} \text{wt}(\sigma) = \sum_{\sigma \in \mathcal{T}} \text{wt}(\sigma).$$

Proof. We present two cases depending on the parity of σ . When σ is even permutation:

$$\begin{aligned} \sum_{\sigma \in \mathcal{S} \setminus \mathcal{T}} (-1)^{\text{sgn}(\sigma)} \text{wt}(\sigma) &= \sum_{\substack{\text{cycles} \\ \gamma \text{ of } \alpha}} \sum_{\alpha \in \gamma} (-1)^{\text{sgn}(\sigma)} \text{wt}(\sigma) \\ &= \frac{1}{2} \sum_{\gamma} \left(\sum_{\sigma \in \gamma} (-1)^{\text{sgn}(\sigma)} \text{wt}(\sigma) + \sum_{\sigma \in \gamma} (-1)^{\text{sgn}(\alpha(\sigma))} \text{wt}(\alpha(\sigma)) \right) \\ &= \frac{1}{2} \sum_{\gamma} \left(\sum_{\sigma \in \gamma} \text{wt}(\sigma) + (-1) \text{wt}(\alpha(\sigma)) \right) \\ &= 0. \end{aligned}$$

If σ is an odd permutation, then

$$\begin{aligned} \sum_{\sigma \in \mathcal{S} \setminus \mathcal{T}} (-1)^{\text{sgn}(\sigma)} \text{wt}(\sigma) &= \sum_{\substack{\text{cycles} \\ \gamma \text{ of } \alpha}} \sum_{\alpha \in \gamma} (-1)^{\text{sgn}(\sigma)} \text{wt}(\sigma) \\ &= \frac{1}{2} \sum_{\gamma} \left(\sum_{\sigma \in \gamma} (-1)^{\text{sgn}(\sigma)} \text{wt}(\sigma) + \sum_{\sigma \in \gamma} (-1)^{\text{sgn}(\alpha(\sigma))} \text{wt}(\alpha(\sigma)) \right) \\ &= \frac{1}{2} \sum_{\gamma} \left(\sum_{\sigma \in \gamma} (-1) \text{wt}(\sigma) + \text{wt}(\alpha(\sigma)) \right) \\ &= 0. \end{aligned}$$

Since the sum of individual elements in $\mathcal{S} \setminus \mathcal{T} = 0$, we then have that

$$\sum_{\sigma \in \mathcal{S}} \text{wt}(\sigma) = \sum_{\sigma \in \mathcal{T}} \text{wt}(\sigma).$$

□

We call α a **sign-reversing bijection**. If $\alpha^2 = 1$ then α is a **sign-reversing involution**.

Theorem 10. (Gessel, Viennot, and Lindström). [13]

Let R be a ring and $D = (V, E)$ be a finite, acyclic, directed graph, embedded in the plane, (Therefore D contains no directed cycles and each vertex has finite degree). Let $A = \{a_1, \dots, a_n\}$ be the set of base vertices of the graph and let $Z = \{z_1, \dots, z_n\}$ be the terminal vertices. Let $P_{i,j}$ denote a directed path connecting a_i to z_j . Let M be the matrix, with entries

$$m_{i,j} = \sum_{P_{i,j}} \text{wt}(P_{i,j}),$$

where the sum is over all paths connecting vertices a_i and z_j . Define \mathcal{T} to be the n -tuple of subgraphs of D consisting of pairwise vertex-disjoint paths (P_1, P_2, \dots, P_n) where P_i is a path from a_i to z_i . Then

$$\det(M) = \sum_{P_i \in \mathcal{T}} \text{wt}(P_i).$$

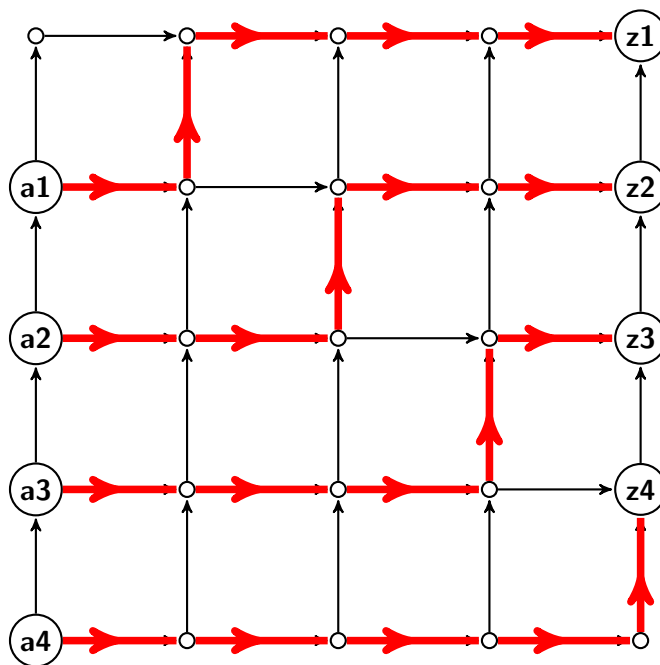

Figure 2.1: An example of a directed, acyclic graph that may be associated with the Gessel, Viennot, and Lindström interpretation for the determinant.

Proof. Let \mathcal{S} be the set of all n -tuples of directed paths $(P_{1,\pi(1)}, \dots, P_{n,\pi(n)})$ where $P_{i,\pi(i)}$ maps a_i to $z_{\pi(i)}$ for a permutation π of \mathfrak{S}_n . Let

$$\text{wt}(P_{1,\pi(1)}, \dots, P_{n,\pi(n)}) := \text{wt}(P_{1,\pi(1)}) \cdots \text{wt}(P_{n,\pi(n)})$$

and

$$\text{sgn}(P_{1,\pi(1)}, \dots, P_{n,\pi(n)}) := \varphi(\pi),$$

where

$$\varphi(\pi) := |\{(i, j) : i < j \text{ and } \pi(i) > \pi(j)\}|.$$

Then $\mathcal{T} \subset \mathcal{S}$ can be viewed as the subset of non-intersecting n -tuples of directed paths. Thus,

$$\text{Let } X := \sum_{P_{1,\pi(1)}, \dots, P_{n,\pi(n)} \in \mathcal{S}} (-1)^{\text{sgn}(P_{1,\pi(1)}, \dots, P_{n,\pi(n)})} \text{wt}(P_{1,\pi(1)}, \dots, P_{n,\pi(n)}).$$

Then

$$\begin{aligned} X &= \sum_{P_{1,\pi(1)}, \dots, P_{n,\pi(n)} \in \mathcal{S}} (-1)^{\text{sgn}(P_{1,\pi(1)}, \dots, P_{n,\pi(n)})} \text{wt}(P_{1,\pi(1)}) \cdots \text{wt}(P_{n,\pi(n)}) \\ &= \sum_{\pi \in \mathfrak{S}_n} (-1)^{\varphi(\pi)} \prod_{i=1}^n \left(\sum_{P_{i,\pi(i)}} \text{wt}(P_{i,\pi(i)}) \right) \\ &= \sum_{\pi \in \mathfrak{S}_n} (-1)^{\varphi(\pi)} m_{1,\pi(1)} m_{2,\pi(2)} \cdots m_{n,\pi(n)} \\ &= \det(M). \end{aligned}$$

Now construct a sign-reversing involution on $\mathcal{S} \setminus \mathcal{T}$, the non-disjoint n -tuples of paths $(P_{1,\pi(1)}, \dots, P_{n,\pi(n)})$. Given a n -tuple of paths $(P_{1,\pi(1)}, \dots, P_{n,\pi(n)})$, let i be the smallest integer such that $P_{i,\pi(i)}$ meets another path. Let v be the first vertex on $P_{i,\pi(i)}$ which also lies on another path. Let $j > i$, be the smallest index such that v lies on $P_{j,\pi(j)}$. Let $P_{i,\pi(i)} = u_1 \dots v \dots u_s$ and $P_{j,\pi(j)} = w_1 \dots v \dots w_r$, be the corresponding paths with vertices u_i, w_i and v . We define the map α where $\alpha(P_{1,\pi(1)}, \dots, P_{n,\pi(n)}) = (Q_{1,\pi(1)}, \dots, Q_{n,\pi(n)})$ such that:

$$Q_{k,\pi(k)} = \begin{cases} P_{k,\pi(k)} & \text{if } k \notin \{i, j\}, \\ u_1 u_2 \dots v \dots w_r & \text{if } k = i, \\ w_1 w_2 \dots v \dots u_s & \text{if } k = j. \end{cases}$$

Continuing this construction we can deform the set of n -tuples of paths with crossings to disjoint paths connecting a_i and z_i . Therefore all that remains is to show that α is a sign-reversing involution.

Claim. α is a sign-reversing involution.

Proof. Since $P_{1,\pi(1)}, \dots, P_{n,\pi(n)}$ and $Q_{1,\pi(1)}, \dots, Q_{n,\pi(n)}$ have the same edge sets then

$$\text{wt}(P_{1,\pi(1)}, \dots, P_{n,\pi(n)}) = \text{wt}(Q_{1,\pi(1)}, \dots, Q_{n,\pi(n)})$$

so the sets have the same weight. In addition, if $\text{sgn}(P_{1,\pi(1)}, \dots, P_{n,\pi(n)})$ is odd then since α multiplies the path $(P_{1,\pi(1)}, \dots, P_{n,\pi(n)})$ by a transposition (i, j) this changes the sign of $\text{sgn}(Q_{1,\pi(1)}, \dots, Q_{n,\pi(n)})$ to be even.

The equivalent holds for the case when $\text{sgn}(P_{1,\pi(1)}, \dots, P_{n,\pi(n)})$ is even. We can then construct an inverse map $\alpha(Q_{1,\pi(1)}, \dots, Q_{n,\pi(n)}) = (P_{1,\pi(1)}, \dots, P_{n,\pi(n)})$ and therefore $\alpha = \alpha^{-1}$. This establishes the claim.

Using the previous proposition, this concludes the proof. □

2.2 Combinatorial Interpretations of Immanants

Section 2.2 aims to set the stage for preceding Theorems 11 and 12 in such a way that they are logical to the reader. We now present some previous interpretations of the immanant for specialized matrices by Greene [18] and Goulden and Jackson [14]. We then present a general interpretation for

- (i) elementary immanants,
- (ii) monomial immanants, as well as,
- (iii) an irreducible character interpretation for immanants indexed by a hook tableau.

2.2.1 Combinatorial Interpretation of Jacobi-Trudi Immanants as Lattice Paths

The following interpretation of immanants of Jacobi-Trudi matrices comes from Greene [18] and is based on conjectures posed by Goulden and Jackson [14]. This combinatorial interpretation proved that the immanant of a Jacobi-Trudi matrix has nonnegative coefficients, and is an important result concerning the positivity of immanants. We state the main theorem from [18] and outline the combinatorial interpretation of the homogeneous symmetric functions from [14]. For further reference the reader can see [18].

In this construction, the immanant of a Jacobi-Trudi matrix is written as:

$$\text{Imm}_\lambda(H(\nu, \mu)) = \sum_{\sigma \in \mathfrak{S}_n} \chi^\lambda(\sigma) \prod_{i=1}^n (h_{(\nu_i - i) - (\mu_{\sigma(i)} - \sigma(i))}). \quad (2.1)$$

This construction interprets the h_k in a Jacobi-Trudi matrix, as a generating function for the number of northeast lattice paths starting at $(0, 1)$ and ending at (k, ∞) . Similarly, this can also enumerate the paths from $(a, 1)$ to $(a + k, \infty)$, for some $a \in \mathbb{Z}$. We define $P_i = (\mu_i - i, 1)$ and $Q_i = (\nu_i - i, \infty)$ for $i = 1, \dots, n$.

Let π be a path on the integer lattice of the real plane, with unit steps \rightarrow, \uparrow in the positive direction of the x -axis and y -axis respectively. Therefore π is a finite sequence of such steps.

Let P_i and Q_i be labelled points on the lattice for $i = 1, \dots, n$. Let π_i be a path connecting P_i and Q_j . We shall call $\pi = (\pi_1, \dots, \pi_n)$ an **ordered n -path**. It is immediate that,

$$\prod_{i=1}^n (h_{(\nu_i - i) - (\mu_{\sigma(i)} - \sigma(i))}),$$

is the generating function for the families of n -paths connecting $P_{\sigma(i)}$ to Q_i , for some permutation $\sigma \in \mathfrak{S}_n$.

Let $h_j(\pi_i)$ be the number of horizontal steps in π_i that start at the y -coordinate j . The weight of path π_i is defined to be

$$\text{wt}(\pi_i) := \prod_j x_j^{h_j(\pi_i)},$$

and the weight of π is defined to be

$$\text{WT}(\pi) := \prod_{i=1}^n \text{wt}(\pi_i).$$

The permutation associated with π is $\theta(\pi) := \sigma \in \mathfrak{S}_n$, where $Q_{\sigma(i)}$ is the terminus of π_i for $i = 1, \dots, n$.

Let J_1, J_2, \dots be intervals of $[n]$. Let \mathfrak{S}_{J_i} be the symmetric group acting on the elements of J_i . Let \mathcal{F} be the set of all ordered n -paths, and let \mathcal{F}_σ be the set of all ordered n -paths with associated permutation $\sigma \in \mathfrak{S}_n$. We assume multiple edges are distinguishable, so that using each edge results in a different \mathcal{F} .

We consider $\text{Imm}_\lambda(H(\nu, \mu))$ where

- $\nu, \mu \vdash N$,
- $\ell(\nu) = \ell(\mu) = n$, so $H(\nu, \mu)$ is an $n \times n$ matrix,
- $\lambda \vdash n$.

From Greene [18]:

$$\text{Imm}_\lambda(H(\nu, \mu)) = \sum_{\sigma \in \mathfrak{S}_n} \chi_\sigma^\lambda \sum_{\pi \in \mathcal{F}_\sigma} \text{WT}(\pi),$$

Now reverse the order of summation. To do this, let

$$\mathcal{F}^\gamma := \text{the set of all } n\text{-paths in } \mathcal{F} \text{ with weight } x^\gamma := x_1^{\gamma_1} x_2^{\gamma_2} \dots, \text{ where } \gamma = (\gamma_1, \gamma_2, \dots).$$

Then

$$\text{Imm}_\lambda(H(\nu, \mu)) = \sum_{\gamma} x^\gamma \sum_{\pi \in \mathcal{F}^\gamma} \chi^\lambda(\theta(\pi)).$$

Claim 1. [18] $\sum_{\pi \in \mathcal{F}^\gamma} \theta(\pi) \in \mathbb{C}\mathfrak{S}_n$ and has form

$$a \cdot S_{J_1} \cdot S_{J_2} \cdots S_{J_p},$$

where

- a is a constant, $a \geq 0$;
- $S_{J_i} := \sum_{\tau \in \mathfrak{S}_{J_i}} \tau$.

In order to obtain the intervals J_1, J_2, \dots we consider the intersection of paths in our n -path π . We will use the following example to demonstrate the construction. Let $m = 3, \nu = \{2, 1, 1\}, \mu = \emptyset$, and $P_i = (\mu_i - i, 1), Q_i = (\nu_i - i, \infty)$. We then consider the following points,

$$\begin{aligned} P_1 &= (-1, 1), Q_1 = (1, \infty), \\ P_2 &= (-2, 1), Q_2 = (-1, \infty), \\ P_3 &= (-3, 1), Q_3 = (-2, \infty). \end{aligned}$$

Figure 2.2 shows a possible n -path, $\pi = (\pi_1, \pi_2, \pi_3)$, with weight $x^\beta = x_2^2 x_3^2$ for $\beta = (0, 2, 2, 0, \dots)$ as we have two horizontal edges of height 2 and height 3. We now consider the points where two paths intersect in order to determine our intervals J_i , moving north-east across the graph.

Our example has three intersection points and we will begin at point a . At point a we can permute the endpoints of π_2 and π_3 and therefore our first factor is $S_{\{2,3\}}$. Moving east we reach point b , where we can permute paths π_1 and π_2 , giving the factor $S_{\{1,2\}}$. At the final intersection point c , we can again switch π_1 and π_2 , giving the factor $S_{\{1,2\}}$. Since multiple edges are allowed, we overcount by a factor of $E := \prod e_i!$, where e_i is the multiplicity of the i th edge. We can then use Claim 1 and the construction to write,

$$\begin{aligned} [x^\beta] \sum_{\gamma} x^\gamma \sum_{\pi \in \mathcal{F}^\gamma} \chi^\lambda(\theta(\pi)) &= \frac{1}{2} \chi^\lambda(S_{\{2,3\}} S_{\{1,2\}} S_{\{1,2\}}), \\ &= \chi^\lambda(I + (1, 2) + (2, 3) + (1, 2, 3)). \end{aligned}$$

We now state the main theorem from Greene [18], conjectured by Goulden and Jackson, without proof.

Theorem 11. (Greene). [18] *Let $J_i \subseteq [n]$ for $i = 1, \dots, n$ be an interval, and let $S_{J_i} = \sum_{\tau \in \mathfrak{S}_{J_i}} \tau$, where \mathfrak{S}_{J_i} is the symmetric group acting on the elements of the interval J_i . For any irreducible character χ^λ ,*

$$\chi^\lambda(S_{J_1} \cdots S_{J_k}) \geq 0.$$

Hence $\text{Imm}_\lambda(H(\nu, \mu))$ is MNN.

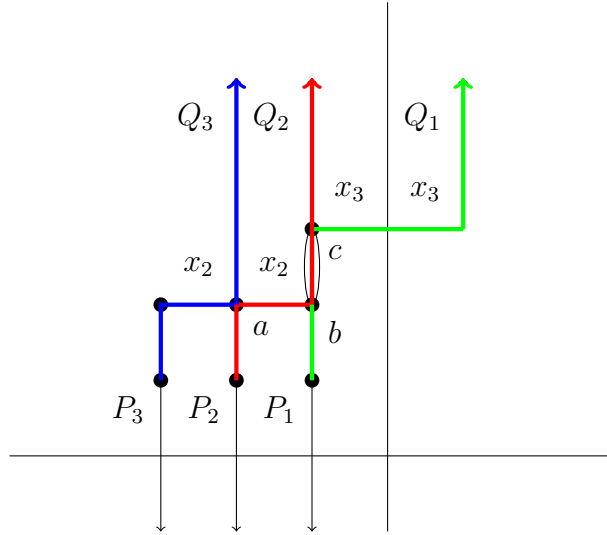

Figure 2.2: Lattice Path Interpretation of Immanants with $\beta = (0, 2, 2, 0, \dots)$.

We now define Young's Seminormal Form, which is a matrix form of the irreducible representation of the symmetric group. This will be used in the statement of the main theorem from [18], which implies Theorem 11. For a partition $\lambda \vdash n$, let T_i denote the i^{th} standard young tableau of shape λ . We then index by last letter order, which is defined as lexicographically ordered by the leftmost entry in the lowest row of the tableau. The ordering then proceeds along the lowest row and continues up the rows.

For example, if $\lambda = (3, 2)$:

$$\begin{array}{c}
 \begin{array}{|c|c|c|} \hline 1 & 3 & 5 \\ \hline 2 & 4 & \\ \hline \end{array} < \begin{array}{|c|c|c|} \hline 1 & 2 & 5 \\ \hline 3 & 4 & \\ \hline \end{array} < \begin{array}{|c|c|c|} \hline 1 & 3 & 4 \\ \hline 2 & 5 & \\ \hline \end{array} < \begin{array}{|c|c|c|} \hline 1 & 2 & 4 \\ \hline 3 & 5 & \\ \hline \end{array} < \begin{array}{|c|c|c|} \hline 1 & 2 & 3 \\ \hline 4 & 5 & \\ \hline \end{array} \\
 T_1 & T_2 & T_3 & T_4 & T_5
 \end{array}$$

Let $\delta(p, q)$ denote the distance from p to q in a tableau T , for two elements of tableau p, q . For example, if p is in row r and column c , and q lies in row r' and column c' , then

$$\delta(p, q) = (c' - r') - (c - r).$$

This then allows us to define the matrix associated with Young's Seminormal Form, $\rho_\lambda(\tau_k)$ for transpositions $\tau_k = (k, k+1)$ for $k = 1, 2, \dots, n-1$. Let $\delta_i = \delta(k, k+1)$ is the distance from k to $k+1$ in the i^{th} tableau T_i . We then define the matrix as follows:

- (i) Diagonal entries (i, i) are $\frac{1}{\delta_i}$, for all i .
- (ii) Off-Diagonal entries are defined as follows:
- If $i \neq j$ and $T_j \neq \tau_k T_i$, then $\rho(\tau_k)|_{i,j} = 0$.
 - Otherwise, if $T_j = \tau_k T_i$, then

$$\rho(\tau_k)|_{i,j} = \begin{cases} 1 - 1/\delta_i^2 & \text{if } i < j, \\ 1 & \text{if } i > j. \end{cases}$$

Therefore $\rho(\tau_k)$ is block diagonal, with blocks of size either 1 or 2. We present an example for clarification.

If $\lambda = (3, 2)$ and $\tau_2 = (2, 3)$, then

$$\rho(\tau_2) = \begin{pmatrix} \frac{1}{2} & \frac{3}{4} & 0 & 0 & 0 \\ 1 & \frac{-1}{2} & 0 & 0 & 0 \\ 0 & 0 & \frac{1}{2} & \frac{3}{4} & 0 \\ 0 & 0 & 1 & \frac{-1}{2} & 0 \\ 0 & 0 & 0 & 0 & 1 \end{pmatrix}.$$

We can now present the main theorems from [18] about the positivity of immanants.

Theorem 12. (Greene). [18] *For an interval $J \subseteq [n]$, and let $S_J = \sum_{\tau \in \mathfrak{S}_J} \tau$, where \mathfrak{S}_J is the symmetric group acting on the elements of the interval J . Let $\rho_\lambda(S_J)$ denote the matrix representing S_J in Young's seminormal representation of \mathfrak{S}_n , indexed by λ . Then $\rho_\lambda(S_J)$ is a matrix with all nonnegative entries.*

Note: This implies Theorem 11, since $\chi^\lambda(S_{J_1} \cdots S_{J_k})$ is the trace of $\rho_\lambda(S_{J_1}) \cdots \rho_\lambda(S_{J_k})$.

Corollary 1. *From this construction, we can also deduce Gessel and Viennot's [13] combinatorial interpretation for the Jacobi-Trudi Theorem. This can be seen as the sign character vanishes on any product of S_J , in which one of the intervals has more than one element. Therefore the only contributions to $H(\mu, \nu)$ are from the non-intersecting families of paths.*

2.2.2 Combinatorial Interpretations for Immanants and the Matrix Tree Theorem

The original proof comes from Goulden and Jackson [14] with further combinatorial developments by Konvalinka [23]. We present the combinatorial interpretation of the immanant

of matrices used in the Matrix Tree Theorem described in Section 1.6. These interpretations use the number of subtableaux with an even or odd number of columns. We begin by describing these immanants in terms of the function, $b_\lambda(f)$ which is defined presently.

Let G be a graph on $n + 1$ vertices. We define the matrix-tree matrix of size n to be,

$$T_n := \left[\delta_{ij} \left(\sum_{l=1}^{n+1} a_{i,l} \right) - a_{i,j} \right]_{n \times n} \quad (2.2)$$

where $a_{i,j}$ marks the occurrence of the directed edge (i, j) in G . The Matrix Tree Theorem [36] states that $\det(T_n)$ is the generating function for the undirected trees on $n + 1$ vertices, rooted at $(n + 1)$.

Let f be a function from $[n]$ to $[n + 1]$. We define a functional digraph of f , to be a directed graph on $[n + 1]$, with edges directed from i to $f(i)$ for all $i \in [n + 1]$ with the following conditions:

- (i) the connected component that contains vertex $n + 1$ is an in-directed tree with root $n + 1$;
- (ii) the other connected components, if any, will consist of a nonempty collection of in-directed trees, with root vertices joined in a directed cycle.

The cycle type of f is defined by $\tau(f) := (1^{i_1} 2^{i_2} \dots)$, where i_j is the number of cycles length $j \geq 1$. We provide an example to clarify these definitions.

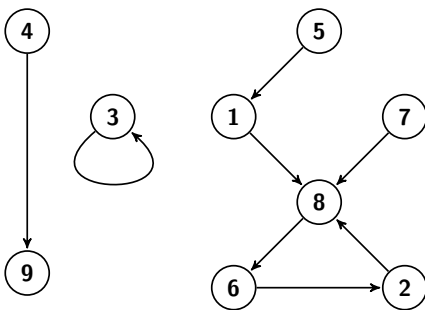

Figure 2.3: The functional digraph of g .

Let $n = 8$ and let g be a function with the following mapping: $g(1) = 8, g(2) = 8, g(3) = 3, g(4) = 9, g(5) = 1, g(6) = 2, g(7) = 8, g(8) = 6$. This function has cycle type $\tau(g) = (3, 1) \vdash 4$ and the following functional digraph in Figure 2.3.

Now consider the space of functions \mathfrak{F}_n , with elements $f : [n] \rightarrow [n + 1]$ such that f has no fixed points. Each monomial that arises in $\text{Imm}_\lambda(T_n)$ is of the form $\prod_{i=1}^n a_{i,f(i)}$ for some $f \in \mathfrak{F}_n$. In addition, We can then write:

$$\text{Imm}_\lambda(T_n) = \sum_{f \in \mathfrak{F}_n} b_\lambda(f) \prod_{i=1}^n a_{i,f(i)},$$

where we can give the following interpretation to the coefficient $b_\lambda(f)$.

Lemma 1. [14] *For any $f \in \mathfrak{F}_n$ with $\tau(f) = \mu = (\mu_1, \mu_2, \dots)$, let F be an $n \times n$ matrix whose elements are defined by*

$$F_{i,j} := \begin{cases} 1 & \text{if } j = f(i) \leq n, \\ 0 & \text{otherwise.} \end{cases}$$

Then:

$$(1) \quad b_\lambda(f) = \text{Imm}_\lambda(I - F),$$

$$(2) \quad b_\lambda(f) = \left\langle s_\lambda, p_1^{n-|\mu|} \prod_{j \geq 1} (p_1^{\mu_j} + (-1)^{\mu_j} p_{\mu_j}) \right\rangle.$$

Proof. (1) Since f has no fixed points, all $b_{i,i} = 1$, as $F_{i,i} = 0$ for all $i = 1, \dots, n$. For each i there is a unique $j = f(i)$, and thus there will be one other entry in row i with $a_{i,j} = -1$.

$$\begin{aligned} b_\lambda(f) &= \left[\prod_{i=1}^n a_{i,f(i)} \right] \text{Imm}_\lambda(T_n), \\ &= \left[\prod_{i=1}^n a_{i,f(i)} \right] \sum_{\sigma \in \mathfrak{S}_n} \chi^\lambda(\sigma) \prod_{i=1}^n a_{i,\sigma(i)}, \\ &= \sum_{\sigma \in \mathfrak{S}_n} \chi^\lambda(\sigma) \left[\prod_{i=1}^n a_{i,f(i)} \right] \prod_{i=1}^n a_{i,\sigma(i)}, \\ &= \sum_{\sigma \in \mathfrak{S}_n} \chi^\lambda(\sigma) \prod_{i=1}^n [a_{i,f(i)}] a_{i,\sigma(i)}. \end{aligned}$$

Since the only permutations that will contribute nonzero values to the immanant are the identity, cycles of f , or a combination of cycle length 1 and cycle of f , we can rewrite $b_\lambda(f)$ as follows,

$$b_\lambda(f) = \sum_{\sigma \in \mathfrak{S}_n} \chi^\lambda(\sigma) \prod_{i=1}^n k_i,$$

where k_i is defined as:

$$k_i := \begin{cases} 1 & \text{if } i = \sigma(i), \\ -1 & \text{if } f(i) = \sigma(i), \\ 0 & \text{otherwise.} \end{cases}$$

This corresponds to the coefficients from $\text{Imm}(I - F)$, which proves the desired result.

(2) Every nonzero term in the expansion of the immanant in (1) corresponds to a permutation with cycles of f or cycles of length 1. Thus the cycle indicator for this set of permutations is,

$$p_1^{n-|\mu|} \prod_{j \geq 1} (p_1^{\mu_j} + p_{\mu_j}).$$

However, for each μ_j cycle, $(-1)^{\mu_j}$ is contributed and from the entries of $-F$. By taking the inner product with the Schur functions, the result follows. \square

We now use the previous lemma to obtain a combinatorial interpretation of $\text{Imm}_\lambda(T_n)$.

Consider a standard tableau T with entries $1, \dots, n$ and a partition $\mu \vdash k \leq n$. We define a canonical subtableau to be a set of consecutive integers whose diagram is a border strip, such that for all $i < j$, all of the integers in row i are strictly smaller than those in row j . An a -canonical subtableau for a vector $a = \langle a_1, \dots, a_m \rangle$, is a canonical subtableau with elements from the set $[a_1 + \dots + a_i] - [a_1 + \dots + a_{i-1}]$ for some $i = 1, \dots, m$. We provide an example for clarification.

Let $\epsilon_{\mu(T)}$ denote the number of μ -canonical subtableaux of T for which the number of columns is even and $o_\mu(T)$ denotes the number of μ -canonical subtableaux with an odd number of columns. The example in Figure 2.4 has $\epsilon_{\mu(T)} = o_\mu(T) = 1$.

1	2	4	5	6
3	7	10	11	12
8				
9				

8
9

10	11
----	----

Figure 2.4: A standard tableau T and the two corresponding μ -canonical subtableaux.

Theorem 13. [14] *For any $f \in \mathfrak{S}_n$ with λ a partition of n and $\mu = \tau(f)$, then*

$$b_\lambda(f) = \sum_T 2^{\epsilon_\mu(T)},$$

where the summation is over all standard tableaux T of shape λ with $o_\mu(T) = 0$.

Proof. Using the construction from the previous lemma,

$$b_\lambda(f) = \langle s_\lambda, \sum_\nu (-1)^{N(\nu)} p_\nu \rangle,$$

where the sum is over all ν obtained from $(\mu_1, \dots, \mu_m, 1^{n-|\mu|})$, by replacing a subset of the μ_j 's by 1^{μ_j} . This gives 2^m choices of ν and $N(\nu)$, is the sum of all the parts of ν that are not of size 1. Thus by the inner product expression for characters,

$$\begin{aligned} b_\lambda(f) &= \sum_\nu (-1)^{N(\nu)} (-1)^{ht_\nu(T)}, \\ &= \sum_T \sum_\nu (-1)^{N(\nu) + ht_\nu(T)}, \end{aligned}$$

where the inner sum is over all ν from above, such that T can be partitioned into ν subtableaux. There are 2^k such ν , where k is the number of μ subtableaux of T .

For a border strip, the number of cells is equal to the numbers of rows minus the number of columns minus 1. In other words, $(-1)^{col_\nu(T)}$, where $col_\nu(T)$ is the sum of the number of columns in the ν subtableaux with an odd number of columns. For every ν containing the corresponding part of μ , there is a corresponding ν' with this part replaced by 1's, and $col_\nu(T)$ and $col_{\nu'}(T)$ have opposite parity. Thus the inner sum is 0 unless $o_\mu(T) = 0$. If $o_\mu(T) = 0$, $col_{\nu'}(T)$ is even for all ν , so the inner sum is 2^k , and the result follows since $k = \epsilon_\mu(T)$. \square

This concludes the overview of representations of immanants for specific matrices.

We now move to present an interpretation by Clearman, Shelton, and Skandera [8] that finds combinatorial interpretations for elementary and monomial immanants. This thesis then presents interpretations for immanants of hook tableaux which we extend in Chapter 4.

2.3 Temperley-Lieb Immanants

We begin this section by describing the Temperley-Lieb Algebra. There is a combinatorial bijection from the planar partitions to **Kauffman diagrams** which are representations of elements of the algebra. We shall discuss the Temperley-Lieb immanants and the interpretations of elementary immanants in terms of colourings of certain elements of the Temperley-Lieb Algebra. Definitions and further explanation can be found in [30].

Definition 24 (Temperley-Lieb Algebra). *The **Temperley-Lieb Algebra** on n elements is a free additive algebra with multiplicative generators, $(t_0, t_1, \dots, t_{n-1})$, subject to relations:*

$$\begin{aligned} t_i^2 &= qt_i & \forall i = 1, \dots, n-1, \\ t_i t_j &= t_j t_i & \text{if } |i-j| > 1, \\ t_i t_{i\pm 1} t_i &= t_i & \forall i = 1, \dots, n-1. \end{aligned}$$

for some indeterminate q . We denote t_0 to be the identity element of the algebra.

We can represent the basis elements, or the n generators, for $\mathfrak{TL}_n(q)$ diagrammatically as shown in Figure 2.5.

From [30], by specializing at $q = 1$ we can construct the homomorphism:

$$\begin{aligned} \theta : \mathbb{C}[\mathfrak{S}_n] &\rightarrow T_n(2), \\ s_i &\rightarrow t_i - 1. \end{aligned}$$

We will use this homomorphism when we construct the Temperley-Lieb immanant.

There is a bijection in [1] between the partitions of n with at most two rows and the

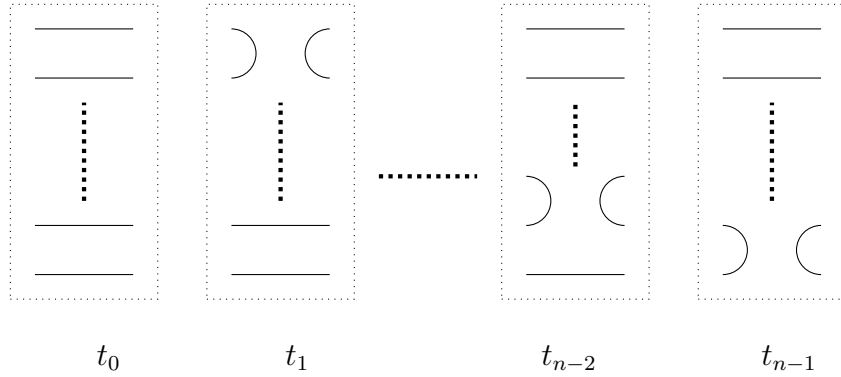

Figure 2.5: Generators of the Temperley-Lieb Algebra.

set of irreducible representations of $\mathfrak{TL}_n(q)$. This bijection was shown to have an interesting combinatorial interpretation in [6], where the elements of the Temperley-Lieb algebra form a bijection with the number of planar partitions. The number of planar partitions of n is $C_n = \frac{1}{n+1} \binom{2n}{n}$ or the Catalan Numbers.

We can now define immanants based on character functions that are in bijections with elements of the Temperley-Lieb algebra. These immanants will be used to prove a combinatorial interpretation for the elementary immanant, later in this chapter.

Definition 25 (Temperley-Lieb Immanants).

$$\text{Imm}_\tau(A) := \sum_{\sigma \in \mathfrak{S}_n} f_\tau(\sigma) a_{1,\sigma(1)} \cdots a_{n,\sigma(n)}, A \in M_n(F).$$

Here f_τ is the family of functions $f_\tau : \mathfrak{S}_n \rightarrow \mathbb{R}$, that maps a permutation σ to the coefficient of τ in $\theta(\sigma)$, where τ is a basis element of $\mathfrak{TL}_n(q)$. We provide an example for clarification:

If we consider the permutation $(321) \in \mathfrak{S}_3$ then this has the representation in the Hecke algebra by $s_1 s_2 s_1$. We then compute:

$$\begin{aligned} \theta(s_1 s_2 s_1) &= (t_1 - 1)(t_2 - 1)(t_1 - 1), \\ &= t_1 t_2 t_1 - t_1 t_2 - t_2 t_1 - t_1^2 + 2t_1 + t_2 - 1. \end{aligned}$$

Using the identities for the Temperley-Lieb algebra,

$$\begin{aligned}\theta(s_1 s_2 s_1) &= t_1 - t_1 t_2 - t_2 t_1 - 2t_1 + 2t_1 + t_2 - 1, \\ &= -t_1 - t_1 t_2 - t_2 t_1 + t_2 - 1.\end{aligned}$$

Therefore taking the coefficient of $\tau = t_1 t_2$, we have

$$\begin{aligned}f_\tau(\sigma) &= [t_1 t_2](-t_1 - t_1 t_2 - t_2 t_1 + t_2 - 1), \\ &= -1.\end{aligned}$$

The algebra $\mathfrak{TL}_n(2)$ may be used for the combinatorial interpretation of the elementary character immanants. Here we demonstrate $\mathfrak{TL}_n(2)$, and the multiplication on the algebra. Multiplication on basis elements is performed by placing two rectangles side by side and contracting the edges so the end points are preserved. Closed loops are replaced by the factor q , in this case 2.

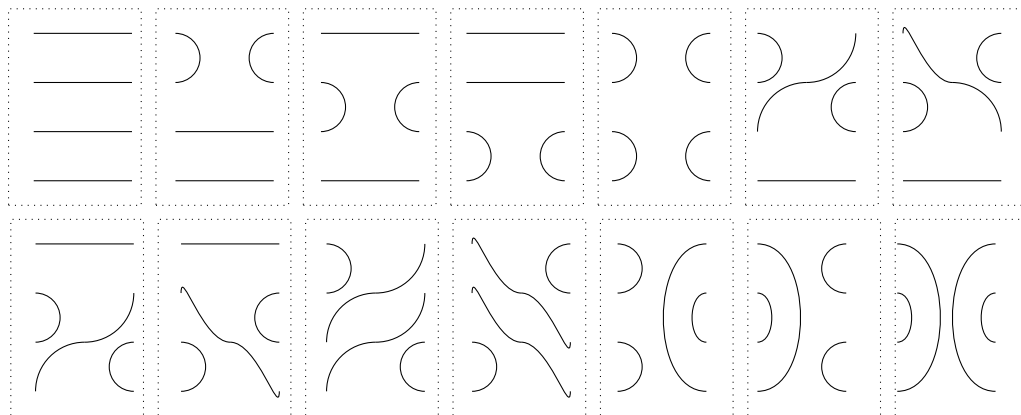

Figure 2.6: The elements of $\mathfrak{TL}_n(2)$.

2.3.1 Colourings of the Temperley-Lieb Algebra

In a Temperley-Lieb diagram, we label the base vertices $B = \{b_1, \dots, b_n\}$ and the terminal vertices $Z = \{z_1, \dots, z_n\}$. We then define a 2-colouring to be an assignment of the vertices

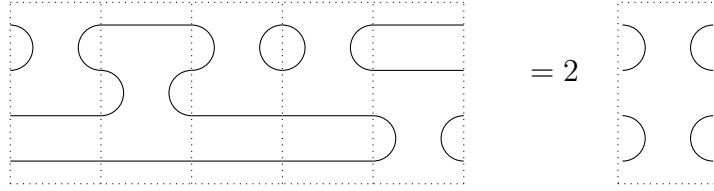

Figure 2.7: Multiplication of elements $t_3t_2t_3t_1 = 2t_1t_3$.

to colours $\{1, 2\}$, such that each pair (b_i, z_i) have the same colour, and two vertices have the same colour if they are connected and one is a base vertex and one is a terminal vertex. We can then define a $(2, \lambda)$ colouring to be the colouring of a partition $\lambda = (\lambda_1, \lambda_2) \vdash n$, if there are λ_1 base vertices with colour 1 and λ_2 terminal vertices with colour 2.

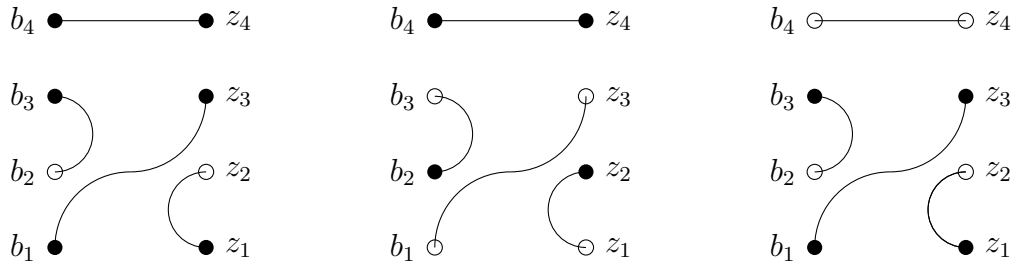

Figure 2.8: Some colourings of the Temperley-Lieb Algebra $\mathfrak{TL}_4(2)$. The leftmost is the colouring for $\lambda = (3, 1)$ and the two right are colourings for $\lambda = (2, 2)$.

Theorem 14. (Elementary Immanants and the Temperley-Lieb Algebra). [8]

For $\lambda \vdash n$ such that $\lambda = (\lambda_1, \lambda_2)$ and let τ be a standard basis element of $\mathfrak{TL}_n(2)$, the coefficient $b_{\lambda, \tau}$ appearing in

$$\text{Imm}_{e^\lambda}(A) = \sum_{\tau} b_{\lambda, \tau} \text{Imm}_{\tau}(A),$$

is equal to the number of $(2, \lambda)$ colourings of τ .

This concludes the interpretation by Clearman, Shelton, and Skandera using elements from the Temperley-Lieb algebra to interpret elementary character immanants. We now consider their interpretation using planar networks and tableaux, which builds upon this characterization of the elementary immanant. In addition, it presents combinatorial interpretations for certain classes of monomial and irreducible character immanants.

2.4 Path Tableaux and Immanants

The following results are from a preprint by Clearman, Shelton, and Skandera [7], which was generously sent to me by Skandera. Theorems are stated in the conference proceedings [8], while the main proofs are located in the unpublished preprint [7]. This section describes a combinatorial interpretation for immanants indexed by a hook tableau. We present the characterization using planar networks and introduce the concept of a path tableau.

2.4.1 Planar Networks

A **R-weighted planar network** of order n , is an acyclic directed multigraph, $G = (V, E)$, with weights ω assigned to its edges. It has n sources labelled $B = \{b_1, \dots, b_n\}$, and n sinks labelled $Z = \{z_1, \dots, z_n\}$. All edges are oriented from sources to sinks, with all sources having in-degree zero and all sinks having out-degree zero. We define a multiset of edges $F = e_1^{k_1} \dots e_n^{k_n}$, where k_i denotes the number of times edge e_i appears in F . The weight of F is multiplicative over edges with,

$$\text{wt}(F) := \text{wt}(e_1)^{k_1} \text{wt}(e_2)^{k_2} \dots \text{wt}(e_n)^{k_n}.$$

A **path matrix**, A is a matrix associated with a R -weighted planar network, such that

$$a_{i,j} = \sum_{\{e_1, \dots, e_n\}} \text{wt}(e_1) \dots \text{wt}(e_n),$$

where the sum is over all sets of edges in a path from b_i to z_j . Note multiple edges between vertices are determined to have the same edge weight, and thus the multiple edges are considered a single edge when counting path families.

Let $P_{i,j}$ denote a path connecting source b_i to sink z_j . For simplification, P_i connects source b_i to sink z_i . A sequence of paths, $\mathfrak{P} = (P_{1,i}, \dots, P_{k,j})$, is called a **path family** if its component paths connect k distinct sources to k distinct sinks. A path family of type 1, $\mathfrak{P} = (P_1, \dots, P_n)$, sends source b_i to sink z_i for all $i = 1, \dots, n$. We denote \mathfrak{P}_σ to be the path family of type σ , which sends b_i to $z_{\sigma(i)}$.

We provide an example for clarification. Note, that this example comes from [8] and all edge weights are set to 1 for simplification. However, we can have R -weighted planar networks with any positive integer as edge weights.

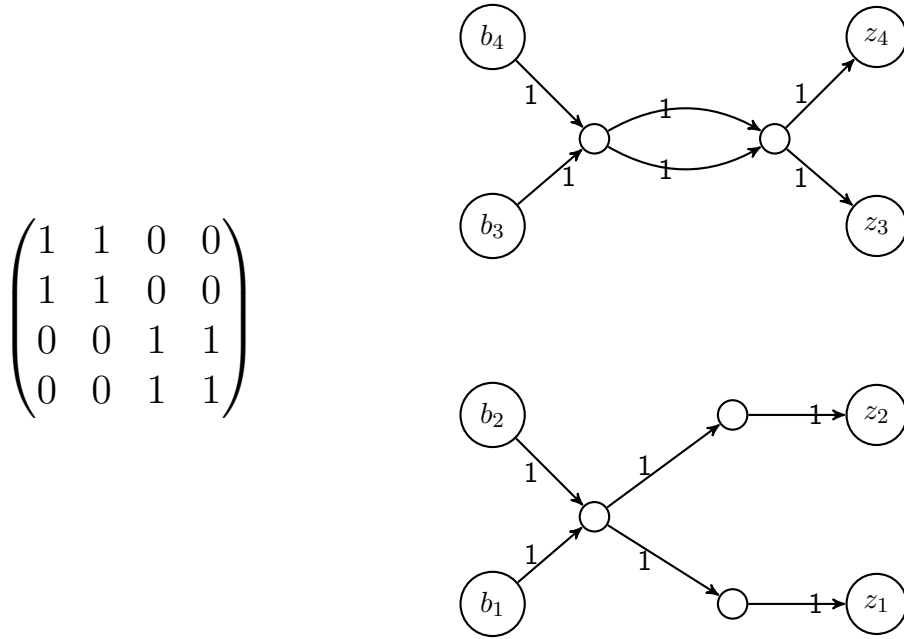

Figure 2.9: Matrix and corresponding R-weighted planar network.

2.4.2 Path Tableaux

A **path tableau** or a **G-Tableau**, is a filling of a Ferrers diagram of shape λ , with a path family of type 1. We also have to consider how the elements in a path tableau are partially ordered. Two paths P_i, P_j in a planar network G are ordered as follows, $P_i <_G P_j$ if:

- (i) $i < j$, and
- (ii) the paths P_i and P_j are vertex disjoint.

We denote a path tableau as **row semistrict** if, for all P_i to the left of P_j , then $P_i \not<_G P_j$. A path tableau is **column strict**, if for all P_i and P_j in the same column, if P_i is above P_j then $i < j$ and P_i and P_j do not intersect. A path tableau is **semistandard** if it is both column strict and row semistrict. If we consider the previous example then we have the following ordering on the paths of type 1:

$$P_1 <_G P_3, \quad P_1 <_G P_4, \quad P_2 <_G P_3, \quad P_2 <_G P_4.$$

The following poset $\{\mathfrak{P}, P_1, P_2, P_3, P_4, <_G\}$, Figure 2.10, diagram to depict the ordering on our paths.

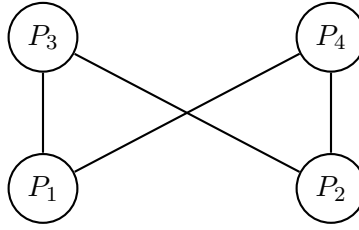

Figure 2.10: Poset ordering of a path family of type 1.

From the following ordering we can then construct 4 semistandard path tableaux and 6 column strict tableaux corresponding to the partition $\lambda = (3, 1)$.

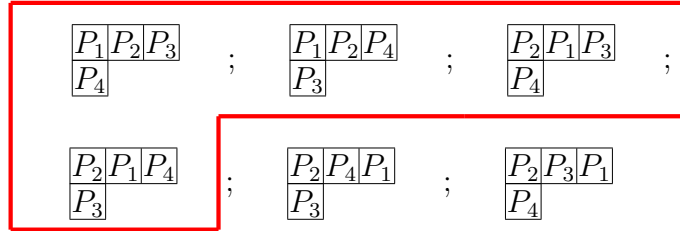

Figure 2.11: Six column strict path tableaux corresponding to the R -weighted planar network G . The first four are also semistandard path tableaux.

2.5 Immanant Interpretations

We now present the immanant interpretations based on the R -weighted planar networks and the corresponding path tableaux from [8]. This leads to a combinatorial interpretation for the elementary and monomial immanants, as well as the irreducible character immanants indexed by hook tableaux. The main theorem by Clearman, Shelton, and Skandera for immanants indexed by hook partitions will be used in my own work in Chapter 4. We present several of the other theorems from this work without proof, as they are used in the main proof and help to illuminate the necessary definitions.

Theorem 15. (Combinatorial Interpretation of Elementary Immanants). [8]
Let R be a \mathbb{C} -algebra and let G be an R -weighted planar network of order n . Let A be the

path matrix associated with the planar network G . Let $\lambda \vdash n$. Then:

$$\text{Imm}_{e^\lambda}(A) = \sum_T \text{wt}(T),$$

where the sum is over all column strict G -tableaux, T , of shape λ' .

We omit the proof, but will use this result for later interpretations by Clearman, Shelton, and Skandera [8], throughout the chapter. We now give a similar interpretation for monomial immanants in terms of path tableau and R -weighted planar networks.

Theorem 16. (Combinatorial Interpretation of Monomial Immanants). [8]

Let R be a \mathbb{C} -algebra and G an R -weighted planar network of order n with path matrix A . Let λ be a partition of n with $\lambda_1 \leq 2$. Then

$$\text{Imm}_{\phi^\lambda}(A) = \sum_T \text{wt}(T),$$

where the sum is over all column strict G -subtableaux, T , of shape λ , such that no column-strict G -tableaux, S , of shape $\mu < \lambda$ satisfies $\alpha_S < \alpha_T$, where α_S, α_T are, respectively, the skeleton tableaux of the path tableaux S , of T .

Before progressing to the proof for irreducible character immanants, we must define some further terminology. A **special ribbon diagram** of shape μ and type λ is a Ferrers diagram of shape μ that is subdivided into ribbons of sizes $\lambda_1, \dots, \lambda_k$, where each λ_i contains a cell from the first row of μ . For a special ribbon diagram D , we define $\text{sgn}(D)$ as -1 to the number of horizontal edges in D .

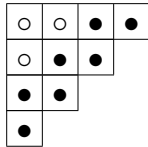

Figure 2.12: A special ribbon diagram with $\mu = (1, 2, 3, 4)$ and $\lambda = (3, 7)$.

We now introduce the following proposition, which we will use in the proof of Theorem 17 for irreducible character immanants.

Proposition 2. *Let $\mu \vdash n$, such that $\mu = (r, 1^{n-r})$ is a hook tableau. Then,*

$$\text{Imm}_\mu(A) = \sum_{\lambda \geq \mu'} (-1)^{r-\ell(\lambda)} c_{\lambda,\mu} \sum_T \text{wt}(T),$$

where the first sum is over all special ribbon diagrams of shape μ and type λ . The second sum is over all column strict path tableaux of shape λ and $c_{\lambda,\mu}$ is the number of special ribbon diagrams of shape μ and type λ .

Proof. We can express irreducible character immanants in terms of elementary immanants as:

$$\text{Imm}_\mu(A) = \sum_{\lambda \geq \mu'} K_{\lambda,\mu'}^{-1} \text{Imm}_{e^\lambda}(A),$$

where

$$K_{\lambda,\mu'}^{-1} = \sum_D \text{sgn}(D).$$

Here the sum is over all special ribbon diagrams, D , of shape μ and type λ . Therefore:

$$\text{Imm}_\mu(A) = \sum_{\lambda \geq \mu'} \sum_{(S,T)} \text{sgn}(S) \text{wt}(T),$$

where the sum is over all pairs (S, T) where S is a special ribbon diagram shape μ , type λ , and T is a column strict path tableau of shape λ for G . When μ is a hook, $(r, 1^{n-r})$, then $\text{sgn}(S) = (-1)^{r-\ell(\lambda)}$ and therefore:

$$\text{Imm}_\mu(A) = \sum_{\lambda \geq \mu'} (-1)^{r-\ell(\lambda)} c_{\lambda,\mu} \sum_T \text{wt}(T),$$

where $c_{\lambda,\mu}$ is the number of special ribbon diagrams of shape μ and type λ and the inner sum is over column strict path tableaux T of shape λ . \square

We can now present the combinatorial interpretation for irreducible character immanants, indexed by hook tableaux.

Theorem 17. (Combinatorial Interpretation for Irreducible Character Immanants of Hook Tableaux). [8]

Let R be a \mathbb{C} -algebra, and G an R -weighted planar network of order n . Let A be the corresponding path matrix of G . Let μ be the hook partition $(r, 1^{n-r})$ of n . Then

$$\text{Imm}_\mu(A) = \sum_T \text{wt}(T),$$

where the sum is over all semistandard G -tableaux, T , of shape μ .

Proof. Let J_μ be the sum of weights of all semistandard G -tableaux T . Then:

$$J_\mu = \sum_\pi w(\pi)A(\pi),$$

where $A(\pi)$ is the number of semistandard path tableaux of shape μ , for a path π . Then applying the Principle of Inclusion-Exclusion, we have

$$A(\pi) = \sum_{S \in \binom{[r-1]}{k}} (-1)^k B(\pi, S),$$

where $B(\pi, S)$, is the number of column strict G -tableaux, T , of shape μ such that:

$$T(1, s) <_P T(1, s + 1), \text{ for } s \in S.$$

We define a ribbon diagram, in this sense, to be a collection of cells in the same column or a collection of cells in the same row which satisfy the above property. Therefore each subset of S corresponds to a special ribbon diagram of shape μ with type λ , for some $\lambda \vdash n$. We can see that $\lambda \geq \mu'$, where μ' is the conjugate tableau of μ and $k = r - \ell(\lambda)$.

It is also clear that if we juxtapose each ribbon upon T , the paths contained in this ribbon will increase upwards and to the right according to our G ranking. Therefore a pair of tableaux (S, T) satisfying $T(1, s) <_P T(1, s + 1)$, for $s \in S$, gives rise to a pair (U, V) where U is a special ribbon diagram of type λ and V is a column strict G -tableau of λ .

Furthermore, there is a bijective correspondence between the pairs (S, T) and (U, V) which we describe as follows:

Let ribbons of U be labelled as $1, \dots, r$ from left to right. For $i = 1, \dots, \ell(\lambda)$, juxtapose column j of V upon the leftmost ribbon of correct length in U , with higher indices below or to the right of lower indices.

Thus we have:

$$A(\pi) = \sum_{\lambda \geq \mu'} (-1)^{r-\ell(\lambda)} C(\pi, \lambda),$$

where $C(\pi, \lambda)$ is the number of pairs, (U, V) , with U a special ribbon diagram of shape μ and type λ , and V is a column-strict G -tableau of shape λ . It then follows that:

$$\begin{aligned} J_\mu &= \sum_{\lambda \geq \mu'} (-1)^{r-\ell(\lambda)} \sum_{\pi} \text{wt}(\pi) C(\pi, \lambda), \\ &= \sum_{\lambda \geq \mu'} (-1)^{r-\ell(\lambda)} c_{\lambda, \mu} \sum_V \text{wt}(V), \end{aligned}$$

where the last sum is over all column strict path tableaux of shape λ and $c_{\lambda, \mu}$ is the number of special ribbon diagrams of shape μ and type λ . Using Proposition 2 concludes the proof. \square

This construction by Clearman, Shelton, and Skandera will serve as a foundation for some of the future combinatorial interpretations, which we shall present in Chapter 4. Specifically, the combinatorial interpretations for hooks will be used in the hope of acquiring an inductive construction of immanants that can extend these combinatorial interpretations.

Chapter 3

Recursive Formulations for Immanants

As mentioned in Chapter 1, there is no convenient formula or polynomial time algorithm for computing the immanant. Therefore, looking at recursive formulations may help to provide further information about its computation. While there is no closed form for the characters of the symmetric group, there is a well studied recursive formulation, the Murnaghan-Nakayama Rule.

We begin with some general recursive constructions on groups and for group characters. We then present some recursive formulations for the immanant of specific types of tableaux. In addition, we introduce a recursive formula and the weighted immanant for all general shapes of tableaux. These constructions will then be used to form combinatorial interpretations in Chapter 4.

We consider rim hooks and rectangular tableaux, and certain cases of tableaux that do not have an explicit formula or a combinatorial construction. This chapter discusses a method for putting these pieces together to calculate Imm_λ for any λ . This can be achieved by using a recursion and results in an algebraic expression for the immanant. This algebraic expression facilitates the extension of Theorem 16 by Clearman, Shelton, and Skandera [8], to immanants that are indexed by tableaux other than hooks. The question remains of extending these algebraic expressions to obtain a concise combinatorial interpretation for the general case. We present some conjectures for this in Chapter 5.

3.1 Branching Rule and Preliminaries

We begin by outlining some definitions and theorems necessary to construct recursive formulae for the immanant. First, we shall detail the deletion and addition of boxes to a Ferrers diagram.

Definition 26 (Inner and Outer Corners). [32] *Let $\lambda \vdash n$, with a corresponding Ferrers diagram.*

- (i) An **inner corner** is a cell $(i, j) \in \lambda$ whose removal leaves the Ferrers diagram of a partition and is denoted λ^- .
- (ii) An **outer corner** is a cell $(i, j) \notin \lambda$ whose addition creates the Ferrers diagram of a partition and is denoted λ^+ .

For example, if $\lambda = (4, 4, 3, 2)$ we have the following inner corners denoted by $*$ and the outer corners denoted by \circ .

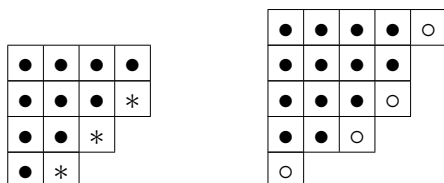

Figure 3.1: Inner and outer corners of a tableau.

It is also natural to examine how the addition or removal of elements affects the symmetric group. As in Chapter 1, we have restricted and induced representations which we can apply to the symmetric group, using the Specht modules. The results may be found, for example, in [32]. We can now present the following branching rule.

Theorem 18. (Branching Rule).

If $\lambda \vdash n$, then

- (i) $S^\lambda \downarrow_{S_{n-1}} \cong \bigoplus_{\lambda^-} S^{\lambda^-}$,
- (ii) $S^\lambda \uparrow^{S_{n+1}} \cong \bigoplus_{\lambda^+} S^{\lambda^+}$.

We now present some convenient ways of considering characters by splitting the partition into smaller parts, and considering the corresponding characters.

Theorem 19. (Splitting Characters).[32]

Consider $(\pi, \sigma) \in \mathfrak{S}_{n-m} \times \mathfrak{S}_m$, where π has type $(\alpha_2, \dots, \alpha_k)$ and σ is an m -cycle. Let $\alpha = \pi\sigma \in \mathfrak{S}_n$. Then,

$$\chi_\alpha^\lambda = \chi^\lambda(\pi\sigma) = \sum_{\mu \vdash n-m} \chi^\mu(\pi) \sum_{\nu \vdash m} c_{\mu,\nu}^\lambda \chi^\nu(\sigma).$$

We note that $c_{\mu,\nu}^\lambda$ is the Littlewood-Richardson coefficient as referenced in Section 1.3.

Proof. Here we use the character ring which we reference in Section 1.2.3. From [32] we have that $\chi^\mu \otimes \chi^\nu$, where $\mu \vdash n-m$ and $\nu \vdash m$, form a basis of $\mathfrak{S}_{n-m} \times \mathfrak{S}_m$. Therefore,

$$\begin{aligned} \chi_\alpha^\lambda &= \chi^\lambda(\pi\sigma) \\ &= \chi^\lambda \downarrow_{\mathfrak{S}_{n-m} \times \mathfrak{S}_m} (\pi\sigma) \\ &= \sum_{\substack{\mu \vdash n-m \\ \nu \vdash m}} m_{\mu,\nu}^\lambda \chi^\mu(\pi) \chi^\nu(\sigma), \end{aligned}$$

where $m_{\mu,\nu}^\lambda$ is identified as the number of ways of expressing an arbitrary $\alpha \in \mathfrak{S}_n$, with partition λ , as $\alpha = \pi\sigma$. Using the Frobenius characteristic map,

$$\begin{aligned} m_{\mu,\nu}^\lambda &= \langle \chi^\lambda \downarrow_{\mathfrak{S}_{n-m} \times \mathfrak{S}_m}, \chi^\mu \otimes \chi^\nu \rangle \\ &= \langle \chi^\lambda, (\chi^\mu \otimes \chi^\nu) \uparrow^{\mathfrak{S}_n} \rangle \\ &= \langle \chi^\lambda, \chi^\mu \cdot \chi^\nu \rangle \\ &= \langle s_\lambda, s_\mu s_\nu \rangle \\ &= c_{\mu,\nu}^\lambda. \end{aligned}$$

Therefore,

$$\chi_\alpha^\lambda = \sum_{\mu \vdash n-m} \chi^\mu(\pi) \sum_{\nu \vdash m} c_{\mu,\nu}^\lambda \chi^\nu(\sigma).$$

Which completes the proof. □

We also have the following Lemma, that can be used to further simplify this expression. We note that \mathfrak{C}_m is the conjugacy class of cycles of length $m \in \mathfrak{S}_m$, ignoring one-cycles. This has combinatorial significance and will be used throughout Chapter 3.

Lemma 2. *If $\nu \vdash m$, then*

$$\chi_{(m)}^\nu = \begin{cases} (-1)^{m-r} & \text{if } \nu = (r, 1^{m-r}), \\ 0 & \text{otherwise.} \end{cases}$$

To motivate the following lemma, we observe that the recursion alluded to above proceeds by the removal of a single node from a tableau. Thus it is necessary to consider the conjugacy class of all permutations with at least one cycle of length one in \mathfrak{S}_n .

Lemma 3. *Let $\lambda \vdash n$, and $\alpha = (1, \alpha_2, \dots, \alpha_k)$ be a partition of n . Then*

$$\chi_\alpha^\lambda = \sum_{\lambda^-} \chi_{\alpha \setminus (1)}^{\lambda \setminus \lambda^-}$$

where the sum is over all λ^- whose removal from λ , leaves a Ferrers diagram.

Proof. This follows from the Murnaghan-Nayakama Rule with $|\xi|=1$ as $(-1)^{l(\xi)} = (-1)^0$. □

3.2 Recursive Constructions for Immanants

We now present some recursive formulations of the immanant, based on the branching rules for the characters of the symmetric group. We shall use these formulations in Chapter 4, to prove some combinatorial interpretations of the immanant. We begin with a restatement of the Murnaghan-Nakayama Rule.

To assist the Examiners, I have attached my name to corollaries and theorems that I have created myself.

Theorem 20. *If $\lambda \vdash n$, and $k \in [n]$ such that $\pi \in \mathfrak{S}_n$ contains a k -cycle. Suppose $\rho \in \mathfrak{S}_n$ is of cycle type π with a k -cycle removed. Then:*

$$\chi^\lambda(\pi) = \sum_{\xi} (-1)^{l(\xi)} \chi^{\lambda \setminus \xi}(\rho),$$

where the sum is over all rim hooks ξ having k cells.

Corollary 2 (Tessier). *Let $\lambda \vdash n$, and λ^- be a single cell deleted from λ , which leaves the resulting tableau $\lambda \setminus \lambda^-$. Let $\alpha = (1, \alpha_2, \dots, \alpha_k)$ be a partition of n with $\alpha'' = (\alpha_2, \dots, \alpha_k)$. Let $A = [a_{i,j}]_{(n-1) \times (n-1)}$, be an $(n-1) \times (n-1)$ matrix and $b \in \mathbb{Z}$. Let M is the $n \times n$ block diagonal matrix with blocks A, b , such that $M = A \oplus [b]_{1 \times 1}$. Then:*

$$\text{Imm}_\lambda(M) = \left(\sum_{\lambda^-} \text{Imm}_{\lambda \setminus \lambda^-}(A) \right) b.$$

Proof. From Corollary 1,

$$\chi_\alpha^\lambda = \sum_{\lambda^-} \chi_{\alpha \setminus (1)}^{\lambda \setminus \lambda^-}.$$

Summing both sides over all $\alpha \in \mathfrak{S}_n$ with $\alpha_1 = 1$ and multiply both sides by matrix entries of A and then b ,

$$\left(\sum_{\alpha} \chi_{\alpha}^{\lambda} \prod_{i=1}^n a_{i, \alpha(i)} \right) b = \left(\sum_{\alpha} \left(\sum_{\lambda^-} \chi_{\alpha \setminus (1)}^{\lambda \setminus \lambda^-} \right) \prod_{i=1}^n a_{i, \alpha(i)} \right) b.$$

Since $m_{(n+1), \alpha(n+1)} = b$ or 0 for all α we can rewrite this as:

$$\sum_{\alpha} \chi_{\alpha}^{\lambda} \prod_{i=1}^n m_{i, \alpha(i)} = \left(\sum_{\alpha} \left(\sum_{\lambda^-} \chi_{\alpha \setminus (1)}^{\lambda \setminus \lambda^-} \right) \prod_{i=1}^n a_{i, \alpha(i)} \right) b.$$

Summing over all λ^- and all $\alpha' = \alpha \setminus (1)$ we can consider this immanant as a restriction to \mathfrak{S}_{n-1} . Therefore,

$$\begin{aligned} \text{Imm}_\lambda(M) &= \left(\sum_{\alpha} \left(\sum_{\lambda^-} \chi_{\alpha \setminus (1)}^{\lambda \setminus \lambda^-} \right) \prod_{i=1}^n a_{i, \alpha(i)} \right) b, \\ &= \left(\sum_{\alpha' \in \mathfrak{S}_{n-1}} \left(\sum_{\lambda^-} \chi_{\alpha'}^{\lambda \setminus \lambda^-} \right) \prod_{i=1}^n a_{i, \alpha(i)} \right) b, \\ &= \left(\sum_{\lambda^-} \text{Imm}_{\lambda \setminus \lambda^-}(A) \right) b. \end{aligned}$$

By switching the order of summation, the result follows. □

The following corollary extends the previous result in the case $M = A \oplus \text{diag}(b_1, \dots, b_{2k-1})$. We consider this case as it allows us to consider combinatorial interpretations for step tableaux in Chapter 4. We now extend the notation λ^- to include the deletion of i cells in a permissible way, i will be clear from the context.

Corollary 3 (Tessier). *Let $\lambda \vdash n$, with k parts and $\lambda_i = \lambda_{i+1} + 1$ for $i = 1, \dots, k$. We then have the following set up:*

- (i) *Let λ^- be the set of $(2k - 1)$ boxes such that the removal leaves the partition with, $\lambda'_i = \lambda_i - 2$ for $i = 1, \dots, k - 1$ and $\lambda'_k = \lambda_k - 1$.*
- (ii) *Let $\alpha = (\alpha_1, \alpha_2, \dots, \alpha_k)$ be a partition of n with $\alpha_i = 2k - 1$ for some i .*
- (iii) *Let $A = [a_{i,j}]$ be an $n - (2k - 1) \times n - (2k - 1)$ matrix and B be an $(2k - 1) \times (2k - 1)$ matrix with entries $b_1, \dots, b_{2k-1} \in \mathbb{Z}$ on the diagonal.*
- (iv) *Let M be the $n \times n$ block diagonal matrix with blocks A, B , with $M = A \oplus B$.*

Then:

$$\text{Imm}_\lambda(M) = (\text{Imm}_{\lambda \setminus \lambda^-}(A)) \prod_{i=1}^{2k-1} b_i.$$

Proof. Using the Murnaghan-Nakayama Rule,

$$\chi_\alpha^\lambda = \sum_{\lambda^-} (-1)^{u(\lambda^-)-1} \chi_{\alpha \setminus (2k-1)}^{\lambda \setminus \lambda^-}.$$

We can pull out the coefficient of either plus or minus 1, depending on whether k is even or odd. Assume for convenience that k is odd. Since there is only one way to remove a rim hook of size $2k - 1$ from a step tableau,

$$\chi_\alpha^\lambda = \chi_{\alpha \setminus (2k-1)}^{\lambda \setminus \lambda^-}.$$

Summing both sides over all $\alpha \in \mathfrak{S}_n$ with $\alpha_i = 2k - 1$ for some i , and multiplying both sides by matrix entries of A ,

$$\left(\sum_{\alpha} \chi_{\alpha}^{\lambda} \prod_{i=1}^{n-(2k-1)} a_{i,\alpha(i)} \right) = \left(\sum_{\alpha} \left(\chi_{\alpha \setminus (2k-1)}^{\lambda \setminus \lambda^-} \right) \prod_{i=1}^{n-(2k-1)} a_{i,\alpha(i)} \right).$$

Since $m_{(n-(2k+1)+i),\alpha(n-(2k-1)+i)} = b_i$ for all α and all $i = 1, \dots, 2k-1$ we can rewrite this as:

$$\sum_{\alpha} \chi_{\alpha}^{\lambda} \prod_{i=1}^n m_{i,\alpha(i)} = \left(\sum_{\alpha} \left(-\chi_{\alpha \setminus (2k-1)}^{\lambda \setminus \lambda^-} \right)^{n-(2k-1)} \prod_{i=1}^{n-(2k-1)} a_{i,\alpha(i)} \right) \prod_i^{2k-1} b_i.$$

Therefore:

$$\begin{aligned} \text{Imm}_{\lambda}(M) &= \left(\sum_{\alpha} \left(\chi_{\alpha \setminus (2k-1)}^{\lambda \setminus \lambda^-} \right)^{n-(2k-1)} \prod_{i=1}^{n-(2k-1)} a_{i,\alpha(i)} \right) \prod_i^{2k-1} b_i, \\ &= \left(\sum_{\alpha' \in \mathfrak{S}_{n-(2k-1)}} \left(\chi_{\alpha'}^{\lambda \setminus \lambda^-} \right)^{n-(2k-1)} \prod_{i=1}^{n-(2k-1)} a_{i,\alpha(i)} \right) \prod_i^{2k-1} b_i, \\ &= (\text{Imm}_{\lambda \setminus \lambda^-}(A)) \prod_i^{2k-1} b_i. \end{aligned}$$

When k is even,

$$\left(\sum_{\alpha} \chi_{\alpha}^{\lambda} \prod_{i=1}^{n-(2k-1)} a_{i,\alpha(i)} \right) = \left(\sum_{\alpha} \left(-\chi_{\alpha \setminus (2k-1)}^{\lambda \setminus \lambda^-} \right)^{n-(2k-1)} \prod_{i=1}^{n-(2k-1)} a_{i,\alpha(i)} \right).$$

Therefore:

$$\begin{aligned} \text{Imm}_{\lambda}(M) &= \left(\sum_{\alpha} \left(-\chi_{\alpha \setminus (2k-1)}^{\lambda \setminus \lambda^-} \right)^{n-(2k-1)} \prod_{i=1}^{n-(2k-1)} a_{i,\alpha(i)} \right) \prod_i^{2k-1} b_i, \\ &= - \left(\sum_{\alpha' \in \mathfrak{S}_{n-(2k-1)}} \left(\chi_{\alpha'}^{\lambda \setminus \lambda^-} \right)^{n-(2k-1)} \prod_{i=1}^{n-(2k-1)} a_{i,\alpha(i)} \right) \prod_i^{2k-1} b_i, \\ &= - (\text{Imm}_{\lambda \setminus \lambda^-}(A)) \prod_i^{2k-1} b_i. \end{aligned}$$

This concludes the proof. □

To deal with the general case, we now introduce the concept of a weighted immanant for the case when $(-1)^{u(\xi)}$ does not always equal 1 in the Murnaghan-Nakayama Rule. We call this the **weighted immanant** and denote it by $\text{WImm}_\lambda(A)$.

Theorem 21. (Recursive formulation for weighted Immanants over certain classes of matrices, Tessler).

Let $\lambda \vdash n$ and let $\alpha = (\alpha_1, \alpha_2, \dots, \alpha_j)$ be a partition of n with $\alpha_j = k$. Let $A = [a_{i,j}]$ be an $(n-k) \times (n-k)$ matrix and B be an $k \times k$ matrix with entries $b_1, \dots, b_k \in \mathbb{Z}$ on the diagonal. Then M is the $n \times n$ block diagonal matrix with blocks A, B . Then:

$$\text{Imm}_\lambda(M) = \left(\sum_{\lambda^-} \text{WImm}_{\lambda \setminus \lambda^-}(A) \right) \prod_{i=1}^k b_i,$$

where the sum is over rim hooks λ^- , of size k , whose removal leaves a Ferrers diagram.

Proof. Using the Murnaghan-Nakayama Rule, we know,

$$\chi_\alpha^\lambda = \sum_{\lambda^-} (-1)^{u(\lambda^-)} \chi_{\alpha \setminus \alpha'}^{\lambda \setminus \lambda^-}.$$

Summing over all $\alpha \in \mathfrak{S}_n$ with α' as a disjoint cycle we get:

$$\sum_{\alpha \in \mathfrak{S}_n} \chi_\alpha^\lambda = \sum_{\alpha \in \mathfrak{S}_n} \sum_{\lambda^-} (-1)^{u(\lambda^-)} \chi_{\alpha \setminus \alpha'}^{\lambda \setminus \lambda^-}.$$

Multiplying by the matrix elements of A and the b_i 's for $i = 1, \dots, k$,

$$\left(\sum_{\alpha} \chi_\alpha^\lambda \prod_{i=1}^{n-k} a_{i, \alpha(i)} \right) \prod_{i=1}^k b_i = \left(\sum_{\alpha} \sum_{\lambda^-} (-1)^{u(\lambda^-)} \chi_{\alpha \setminus \alpha'}^{\lambda \setminus \lambda^-} \prod_{i=1}^{n-k} a_{i, \alpha(i)} \right) \prod_{i=1}^k b_i.$$

Since $m_{(n-k+i), \alpha(n-k+i)} = b_i$ for all α and all $i = 1 \dots k$ we can rewrite this as:

$$\left(\sum_{\alpha} \chi_\alpha^\lambda \prod_{i=1}^n m_{i, \alpha(i)} \right) = \left(\sum_{\alpha} \sum_{\lambda^-} (-1)^{u(\lambda^-)} \chi_{\alpha \setminus \alpha'}^{\lambda \setminus \lambda^-} \prod_{i=1}^{n-k} a_{i, \alpha(i)} \right) \prod_{i=1}^k b_i.$$

We can restrict the summation on the left hand side to $\alpha'' \in \mathfrak{S}_{n-k}$. Therefore,

$$\begin{aligned} \text{Imm}_\lambda(M) &= \left(\sum_{\lambda^-} (-1)^{l(\lambda^-)} \sum_{\alpha'' \in \mathfrak{S}_{n-k}} \chi_{\alpha''}^{\lambda^-} \prod_{i=1}^{n-k} a_{i, \alpha(i)} \right) \prod_{i=1}^k b_i, \\ &= \sum_{\lambda^-} \text{WImm}_{\lambda \setminus \lambda^-}(A) \prod_{i=1}^k b_i. \end{aligned}$$

This concludes the proof. □

The previous recursions will be used in Chapter 4, to allow us to consider combinatorial interpretations of the immanant in terms of smaller parts.

Chapter 4

Combinatorial Interpretations derived from Recursive Formulations

We now present original results based on extensions from previous interpretations. We begin by describing a general interpretation for immanants of certain classes of matrices. We extend the interpretation of R -weighted planar networks to larger rectangular tableaux. In addition, we describe an interpretation of permanents in terms of G -tableaux for R -weighted networks. We then describe cases in which the planar network interpretation from Clearman, Shelton, and Skandera [8] is not applicable, and present some ways in which we may be able to extend these in the future research.

4.1 Interpretations for Immanants on Certain Classes of Matrices

We begin which interpret the immanant, using the R -weighted planar network construction, on matrices with a restricted structure. The first result is for triangular matrices.

Theorem 22. (Immanants of Triangular Matrices, Tessier).

Suppose A is a triangular matrix, corresponding to a path matrix of an R -weighted planar network G . There exists a path family of type 1, denoted by \mathfrak{P} , corresponding to this planar network. Let $\lambda \vdash n$, then

$$\text{Imm}_\lambda(A) = \sum_T \text{wt}(T),$$

where the sum is over all G -tableaux, T , of shape λ , where a G -tableau is a filling of a tableau with a path family of type 1.

Proof. Suppose A is a triangular matrix with entries $a_{i,j}$ corresponding to the multiplicative weight of the path from source i to sink j . Let \mathfrak{P} denote the path family of type 1 with paths, P_1, P_2, \dots, P_n , going from source i to sink i , for $i = 1, \dots, n$. Then,

$$\prod_{i=1}^n a_{i,\sigma(i)} = 0$$

unless $\sigma(i) = i$ for all $i = 1, \dots, n$. Therefore

$$\begin{aligned} \text{Imm}_\lambda(A) &= \sum_{\sigma \in \mathfrak{S}_n} \chi^\lambda(\sigma) \prod_{i=1}^n a_{i,\sigma(i)}, \\ &= \chi^\lambda(id) \prod_{i=1}^n a_{i,i}. \end{aligned}$$

Since $\chi^\lambda(id) = f^\lambda$ for all $\lambda \vdash n$,

$$\begin{aligned} \text{Imm}_\lambda(A) &= f^\lambda \prod_{i=1}^n a_{i,i}, \\ &= |\{\text{SYT of shape } \lambda\}| \cdot \prod_{P_i \in \mathfrak{P}} P_i. \end{aligned}$$

Since there is only one path family of type 1 in this planar network, and no paths intersect.

$$\text{Imm}_\lambda(A) = \sum_T \text{wt}(T).$$

Therefore we can interpret the immanant of a diagonal matrix in terms of G -tableaux. \square

This construction can be extended using the branching rules for immanants to the set of all block triangular matrices.

Theorem 23. (Immanants of Block Triangular Matrices, Tessier).

Suppose A is a block diagonal matrix, such that each diagonal block $B_{i,i}$ for $i = 1, \dots, m$

is triangular. In addition, let \mathfrak{P} denote the path family of type 1 corresponding to the R -weighted planar network G . Then

$$\text{Imm}_\lambda(A) = \sum_T \text{wt}(T),$$

where the sum is over all G -tableaux, T , of shape λ .

Proof. Suppose A is a block diagonal matrix with entries $a_{i,j}$ corresponding to the multiplicative weight of the path from source i to sink j . In addition, let each block $B_{i,i}$ for $i = 1, \dots, m$ be a triangular submatrix with size k_i for block $B_{i,i}$. Let \mathfrak{P} denote the path family of type 1 with paths, P_1, P_2, \dots, P_n , going from source i to sink i , respectively. Then $\prod_{i=1}^n a_{i,\sigma(i)} = 0$ unless $\sigma(i) = i$ for $i = 1, \dots, n$. Therefore

$$\text{Imm}_\lambda(A) = \sum_{\sigma \in \mathfrak{S}_n} \chi^\lambda(\sigma) \prod_{i=1}^n a_{i,\sigma(i)}.$$

From Chapter 3 we have:

$$\text{Imm}_\lambda(A) = \left(\sum_{\lambda^-} \text{Imm}_{\lambda \setminus \lambda^-}(A) \right) \prod_{i=1}^{k_j} b_j.$$

Since $a_{i,\sigma(i)} = 0$ unless σ is the identity, $\chi^\lambda(id)$ is the only character which appears in the computation of the immanant. Thus we can consider the immanant to be sum of the immanants achieved by removing one block at a time. Therefore:

$$\text{Imm}_\lambda(A) = \chi^\lambda(id) \prod_{i=1}^n a_{i,i}.$$

Then since $\chi^\lambda(id) = f^\lambda$, for all $\lambda \vdash n$,

$$\begin{aligned} \text{Imm}_\lambda(A) &= f^\lambda \prod_{i=1}^n a_{i,i}, \\ &= |\{\text{SYT of shape } \lambda\}| \cdot \prod_{P_i \in \mathfrak{P}} P_i, \\ &= \sum_T \text{wt}(T), \end{aligned}$$

which completes the proof. □

This concludes the interpretations for immanants on particular classes of matrices. These cases serve as an important basis for further extending the combinatorial interpretations of the immanant. In addition, the triangular and block triangular matrices cover a number of cases for planar graphs especially when dealing with bipartite graphs.

Throughout the course of this thesis many computations of immanants were done using the Maple programs listed in Appendix A. Based on these preliminary results we also provide a conjecture for block diagonal matrices.

Conjecture 1 (Tessier). *For block diagonal matrices we can also extend the interpretation of the path tableaux for an R -weighted planar network for certain classes of tableaux. In particular, the computational results indicate strong possibility of this interpretation for larger classes of rectangular tableaux.*

We now progress to interpretations of the immanants specializations, the determinant and permanent. We provide interpretations using the R -weighted planar network construction and additionally, extend some interpretations from Section 2.1.

4.2 Interpretations for Permanents and Determinants

We now present some interpretations using the path tableaux and planar network construction to extend the interpretation permanents of binary matrices to permanents of a path matrix. In addition, we state a corollary for the determinant based on the theorem of Gessel, Viennot, and Lindström. These are distinct in nature and are end results, so we shall refer to them as theorems.

Define a **Standard Path Tableau**, to be a path tableau such that:

- (i) if P_i is above P_j then, $P_i <_G P_j$,
- (ii) if P_i is to the left of P_j then, either $P_i <_G P_j$ or, P_i and P_j intersect and $j > i$.

For brevity, let SPT denote the Standard Path Tableaux.

Theorem 24. (Permanents and Path Tableaux, Tessier).

Let G be an R -weighted planar network with corresponding path matrix A . Let \mathfrak{P}_σ denote a path family of type σ with P_i a path from source i to sink $\sigma(i)$. Then

$$\text{Per}(A) = \sum_{\sigma \in \mathfrak{S}_n} |\{\text{SPT shape } \lambda \text{ with content } P_i \in \mathfrak{P}_\sigma\}| \cdot \text{wt}(\mathfrak{P}_\sigma).$$

Proof. Let us consider:

$$\text{Let } X := \sum_{\sigma \in \mathfrak{S}_n} |\{\text{SPT shape } \lambda \text{ with content } P_i \in \mathfrak{P}_\sigma\}| \cdot \text{wt}(\mathfrak{P}_\sigma).$$

Since for the permanent $\lambda = (n)$ we have exactly one standard filling of the path tableaux shape λ ,

$$X = \sum_{\sigma \in \mathfrak{S}_n} \text{wt}(\mathfrak{P}_\sigma).$$

Since each path family corresponds to a unique permutation and we compute the weight of a path family multiplicatively,

$$X = \sum_{\sigma \in \mathfrak{S}_n} \prod_{i=1}^n P_i \text{ for } P_i \in \mathfrak{P}_\sigma.$$

Since each entry in the path matrix A corresponds path in our path family,

$$X = \sum_{\sigma \in \mathfrak{S}_n} \prod_{i=1}^n a_{i,\sigma(i)} = \text{Per}(A),$$

which concludes the proof. □

We can extend the interpretation of the permanents for perfect matchings on binary matrices to permanents of R -weighted planar networks using a path matching. We define a path matching to be a set of paths connecting n distinct sources and n distinct sinks.

Theorem 25. (Permanents and Path Matchings, Tessier).

Let G be an R -weighted planar network, with corresponding path matrix A . Let \mathfrak{P}_σ denote a path family of type σ , with $P_{i,j}$ a path from source i to sink $\sigma(i) = j$. Then

$$\text{Per}(A) = \sum_M \text{wt}(M),$$

where M corresponds to a path matching in G .

Proof. We define the weight of a path matching to be the product of the weight of edges in the matching. From the proof in Chapter 2, each perfect matching corresponds to a unique permutation. We can extend this same result to a path matching on n sources and n sinks. Let M_σ denote the path matching associated with the permutation σ . Therefore:

$$\sum_M \text{wt}(M) = \sum_{\sigma \in \mathfrak{S}_n} \text{wt}(M_\sigma).$$

Since the weight of the matching is equal to the product of its edges

$$\sum_M \text{wt}(M) = \sum_{\sigma \in \mathfrak{S}_n} \prod_{i=1}^m e_{i, \sigma(i)} \text{ for } e_{i, \sigma(i)} \in M_\sigma.$$

Since each entry in the path matrix A corresponds to an edge in our path matching,

$$\sum_M \text{wt}(M) = \sum_{\sigma \in \mathfrak{S}_n} \prod_{i=1}^n a_{i, \sigma(i)} = \text{Per}(A),$$

which concludes the proof. □

Additionally, we can extend the interpretation of the permanents for perfect matchings on binary matrices to permanents of weight matrices of a bipartite graph.

Corollary 4. (Permanents and Weighted Perfect Matchings, Tessier).

Let G be an R -weighted planar network, in the form of a bipartite graph, with corresponding path matrix A . Let \mathfrak{P}_σ denote a path family of type σ , with $P_{i,j}$ a path from source i to sink $\sigma(i) = j$. Then

$$\text{Per}(A) = \sum_M \text{wt}(M),$$

where M corresponds to a perfect matching in G .

We now state a corollary for determinants based on the previous construction by Gessel, Viennot, and Lindström in Chapter 2. We make the observation, which is included for interest, that the Gessel, Viennot, and Lindström theorem has the following restatement, albeit more specialized, in terms of R -weighted planar networks.

Corollary 5 (Tessier). *The determinant of a path matrix of an R -weighted planar network can also be interpreted combinatorially as the sum of weights of path tableaux, with content type 1.*

We now consider the generalization of the permanent and determinant indexed by certain tableaux.

4.3 Interpretations for Hook Additions

We now consider recursive formulations for immanants by adding boxes to hook tableaux. We begin by considering a base case. The interpretations for hooks applies to the case where we have a single cell addition to the hook of size 3.

Claim 2. (Immanants of 2×2 box).

Suppose we have an R -weighted planar network on, $n = 3$, and let $\mu = (2, 1)$. If we add a path P_4 that is independent of all other existing paths in our path family of type 1, then for $\lambda = (2, 2)$,

$$\text{Imm}_\lambda(M) = \sum_T \text{wt}(T),$$

where M is the block diagonal matrix with path matrix A and block b such that, $M = A \oplus [b]_{1 \times 1}$. Here the sum is over all semistandard G -tableaux, T , of shape λ .

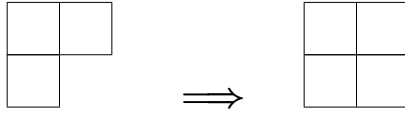

Figure 4.1: Addition on a hook $\lambda = (2, 1)$

Proof. From the branching rules in the previous chapter we have,

$$\text{Imm}_\lambda(M) = (\text{Imm}_{\lambda \setminus \lambda^-}(A)) \cdot b.$$

Since there is only one way to remove a block from λ . In addition, we can interpret the immanant of hooks as in Chapter 2,

$$\text{Imm}_\lambda(M) = \left(\sum_S \text{wt}(S) \right) \cdot b,$$

where the sum is over all semistandard G -tableaux shape $\lambda \setminus \lambda^-$. Since P_4 is disjoint from all other paths, $P_i <_G P_4$ for $i = 1, 2, 3$ in \mathfrak{P} . Thus, there is only one square P_4 can be placed in λ . Therefore,

$$\begin{aligned} & |\{\text{Semistandard } G\text{-tableaux shape } \lambda \setminus \lambda^- \text{ with entries } P_1, P_2, P_3\}| \\ &= |\{\text{Semistandard } G\text{-tableaux shape } \lambda \text{ with entries } P_1, P_2, P_3, P_4\}|. \end{aligned}$$

Since P_4 contributes weight b to all G -tableaux, therefore

$$\begin{aligned} \text{Imm}_\lambda(M) &= |\{\text{Semistandard } G\text{-tableaux shape } \lambda \text{ with entries } P_1, P_2, P_3, P_4\}|, \\ &= \sum_T \text{wt}(T), \end{aligned}$$

where the sum is over all semistandard G -tableaux, T , of shape λ . Therefore the planar network interpretation extends on the base case. \square

The interpretation from Clearman, Shelton, and Skandera holds in this case because the number of semistandard path tableaux in both $\lambda \setminus \lambda^-$ and λ with the added path remain constant. This will indeed hold for any tableau in which the number of fillings of the tableau remain constant when new boxes are added to a hook and the only change applies to the weight of path family. However, when we consider tableaux with more complicated addition we must make further modifications to our interpretation.

The previous description by Clearman, Shelton, and Skandera [8] does not necessarily extend to tableaux on other classes. This is mainly caused by the complication of adding boxes increasing the number of G -tableaux. Additionally, complications arise when there are more than one path family of type 1 in the planar network. As multiple edges are allowed in these planar networks, there is account for multiple path families when considering further combinatorial interpretations of the immanant on general tableaux.

For example, we may construct the following planar network with path matrix A on six vertices.

Example 3.

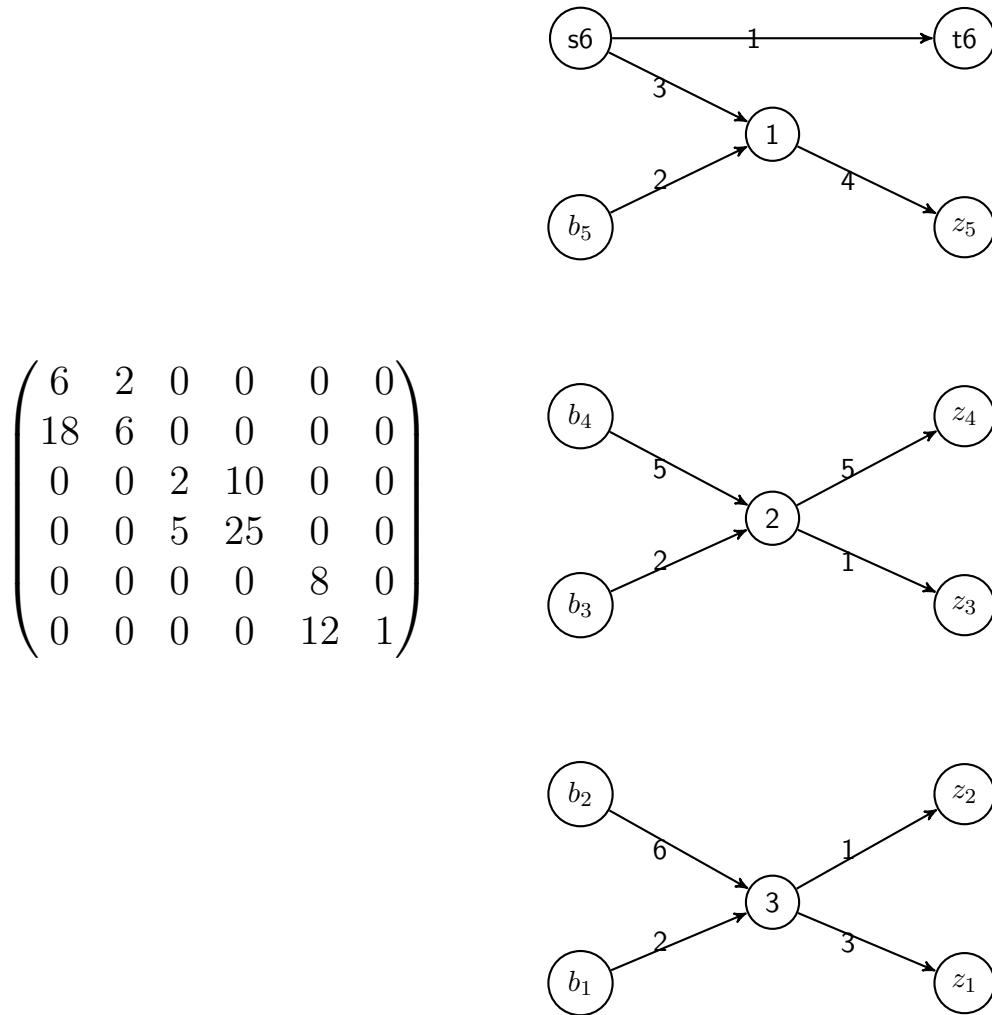

Figure 4.2: Counterexample to the R -weighted planar network construction, in the general case.

We have the following ordering on the paths of type 1:

$$\begin{array}{cccccc}
P_1 <_G P_3, & P_1 <_G P_4, & P_1 <_G P_5, & P_1 <_G P_6, & P_2 <_G P_3, \\
P_2 <_G P_4, & P_2 <_G P_5, & P_2 <_G P_6, & P_3 <_G P_5, & P_3 <_G P_6, \\
& P_4 <_G P_5, & P_4 <_G P_5, & P_5 <_G P_6. &
\end{array}$$

These give rise to the following semistandard path tableaux.

$\begin{array}{ c c c c } \hline P_1 & P_2 & P_3 & P_4 \\ \hline P_5 & P_6 & & \\ \hline \end{array}$	$\begin{array}{ c c c c } \hline P_1 & P_2 & P_4 & P_3 \\ \hline P_5 & P_6 & & \\ \hline \end{array}$	$\begin{array}{ c c c c } \hline P_1 & P_2 & P_3 & P_5 \\ \hline P_4 & P_6 & & \\ \hline \end{array}$	$\begin{array}{ c c c c } \hline P_1 & P_2 & P_4 & P_5 \\ \hline P_3 & P_6 & & \\ \hline \end{array}$
$\begin{array}{ c c c c } \hline P_2 & P_1 & P_3 & P_4 \\ \hline P_5 & P_6 & & \\ \hline \end{array}$	$\begin{array}{ c c c c } \hline P_2 & P_1 & P_4 & P_3 \\ \hline P_5 & P_6 & & \\ \hline \end{array}$	$\begin{array}{ c c c c } \hline P_2 & P_1 & P_3 & P_5 \\ \hline P_4 & P_6 & & \\ \hline \end{array}$	$\begin{array}{ c c c c } \hline P_2 & P_1 & P_4 & P_5 \\ \hline P_3 & P_6 & & \\ \hline \end{array}$
$\begin{array}{ c c c c } \hline P_1 & P_2 & P_5 & P_6 \\ \hline P_3 & P_4 & & \\ \hline \end{array}$	$\begin{array}{ c c c c } \hline P_1 & P_2 & P_5 & P_6 \\ \hline P_4 & P_3 & & \\ \hline \end{array}$	$\begin{array}{ c c c c } \hline P_1 & P_2 & P_3 & P_6 \\ \hline P_4 & P_5 & & \\ \hline \end{array}$	$\begin{array}{ c c c c } \hline P_1 & P_2 & P_4 & P_6 \\ \hline P_3 & P_5 & & \\ \hline \end{array}$
$\begin{array}{ c c c c } \hline P_2 & P_1 & P_5 & P_6 \\ \hline P_3 & P_4 & & \\ \hline \end{array}$	$\begin{array}{ c c c c } \hline P_2 & P_1 & P_5 & P_6 \\ \hline P_4 & P_3 & & \\ \hline \end{array}$	$\begin{array}{ c c c c } \hline P_2 & P_1 & P_3 & P_6 \\ \hline P_4 & P_5 & & \\ \hline \end{array}$	$\begin{array}{ c c c c } \hline P_2 & P_1 & P_4 & P_6 \\ \hline P_3 & P_5 & & \\ \hline \end{array}$

Figure 4.3: Sixteen semistandard path tableaux corresponding to the R -weighted planar network G .

Using this planar network we can establish a counterexample that shows the interpretation by Clearman, Shelton, and Skandera does not extend in general. If $\lambda \vdash 6 = (4, 2)$ then $\text{Imm}_\lambda(A) = 14400$. The path family of type 1 has weight 2400 and there are 16 path tableaux of shape λ . Thus by the previous construction, the immanant should be 38440. Therefore the construction does not hold in this case.

Despite this interpretation not extending generally, we can extend it in certain cases. We now present some possible extensions of this characterization for rectangular partitions of n , with two parts.

Theorem 26. ($2 \times m$ Rectangular Tableaux Interpretations, Tessier).

Let $\lambda \vdash 2m$ be a $2 \times m$ rectangular tableau. Let M be the path matrix of a corresponding R -weighted planar network, G , with a $m \times m$ block, B with entries b_1, \dots, b_m , such that

$M = A \oplus B$. Then

$$\text{Imm}_\lambda(A) = \left(\sum_T \text{wt}(T) - \sum_S \text{wt}(S) \right) \prod_{i=1}^m b_i,$$

where the first sum is over all G -tableaux of shape (m) and the second sum is over all G -tableaux of shape $(m-1, 1)$.

Proof. Using the recursive structure from Chapter 3,

$$\text{Imm}_\lambda(M) = \left(\sum_{\lambda^-} (-1)^{u(\lambda \setminus \lambda^-)} \text{Imm}_{\lambda^-}(A) \right) \prod_{i=1}^m b_i.$$

Since each permutation that will contribute a nonzero entry to the immanant must have b_1, \dots, b_m , we can remove a rim hook of size m . We let $\mu = (m)$ and $\nu = (m-1, 1)$.

$$\text{Imm}_\lambda(M) = (\text{Imm}_\mu(A) - \text{Imm}_\nu(A)) \prod_{i=1}^m b_i.$$

Using the interpretation for hooks by Clearman, Shelton, and Skandera

$$\text{Imm}_\lambda(M) = \left(\sum_T \text{wt}(T) - \sum_S \text{wt}(S) \right) \prod_{i=1}^m b_i,$$

which concludes the proof. \square

In a similar fashion, we can also extend the permutation in terms of path tableaux to the case of a $m \times 2$ rectangular tableau.

Corollary 6. ($m \times 2$ Rectangular Tableaux, Tessier).

Let $\lambda \vdash 2m$ be a $m \times 2$ rectangular tableau. Let M be the path matrix of a corresponding R -weighted planar network, G , with a $m \times m$ block, B with entries b_1, \dots, b_m , such that $M = A \oplus B$. Then

$$\text{Imm}_\lambda(A) = \left((-1)^{m-1} \sum_T \text{wt}(T) + (-1)^{m-2} \sum_S \text{wt}(S) \right) \prod_{i=1}^m b_i,$$

where the first sum is over all G -tableaux of shape (1^m) and the second sum is over all G -tableaux of shape $(2, 1^{m-2})$.

Proof. Using the recursive structure from Chapter 3,

$$\text{Imm}_\lambda(M) = \left(\sum_{\lambda^-} (-1)^{u(\lambda \setminus \lambda^-)} \text{Imm}_{\lambda^-}(A) \right) \prod_{i=1}^m b_i.$$

Since each permutation that will contribute a nonzero entry to the immanant must have b_1, \dots, b_m , we can remove a rim hook of size m . We let $\mu = (1^m)$ and $\nu = (2, 1^{m-2})$. First we consider the case when m is even. Then

$$\begin{aligned} \text{Imm}_\lambda(M) &= ((-1)^{m-1} \text{Imm}_\mu(A) + (-1)^{m-2} \text{Imm}_\nu(A)) \prod_{i=1}^m b_i. \\ &= (-\text{Imm}_\mu(A) + \text{Imm}_\nu(A)) \prod_{i=1}^m b_i. \end{aligned}$$

Using the interpretation for hooks by Clearman, Shelton, and Skandera

$$\text{Imm}_\lambda(M) = \left(- \sum_T \text{wt}(T) + \sum_S \text{wt}(S) \right) \prod_{i=1}^m b_i.$$

Now considering the case when m is odd,

$$\begin{aligned} \text{Imm}_\lambda(M) &= (\text{Imm}_\mu(A) - \text{Imm}_\nu(A)) \prod_{i=1}^m b_i, \\ &= \left(\sum_T \text{wt}(T) - \sum_S \text{wt}(S) \right) \prod_{i=1}^m b_i. \end{aligned}$$

which concludes the proof. □

From these two cases for rectangular tableaux we then deduced the following corollary.

Corollary 7 (Tessier). *Let $\lambda \vdash n$ such that λ can be decomposed into subtableaux that are hooks. Let M be the corresponding path matrix and let M have a block decomposition such that when rim hooks are removed from λ a hook tableau remains. Then we can interpret Imm_λ as the signed sum of the G -tableaux for each of the hook tableaux that are subtableaux of λ .*

4.3.1 Cell Additions on Hooks

We now consider the case of adding a single box to a hook and considering the resulting combinatorial structure. We begin by examining the cases that are possible by adding λ^+ to a tableau.

Consider a hook $\lambda = (r, 1^{n-r})$. When adding a cell to λ there are three possible additions, as shown in the figure below.

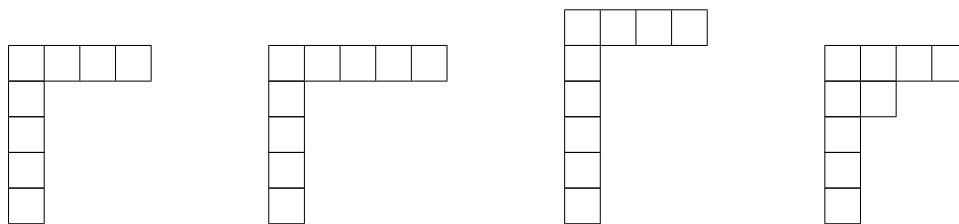

Figure 4.4: Additions for Hook Tableaux.

We can recursively construct a combinatorial interpretation on tableaux with single cell additions to a hook diagram. The interpretation is clear for tableaux where the addition of a cell produces another hook, as we can simply apply the interpretation by Clearman, Shelton, and Skandera. We will only address the case where a cell is added to the second row of the hook partition.

Theorem 27. (Additions on hooks).

Let $\lambda \vdash n$ such that $\lambda = (r, 1^{n-r})$, and let $\lambda^+ = (r, 2, 1^{n-r}) \vdash n + 1$. Let M have the appropriate matrix structure with a block submatrix of size $n - 3$. Then we can sequentially deform $\text{Imm}_{\lambda^+}(M)$ in terms of hook tableau, and then apply the combinatorial construction of Clearman, Shelton, and Skandera presented in Chapter 2.

Proof. We omit as the proof follows the same structure as Theorem 26 but continues the recursion until the tableau is in terms of a signed summation of G -tableaux which are hooks. □

This concludes the combinatorial interpretations of the immanant indexed by a specific tableau. We now discuss a case that we were not able to achieve a closed form for but, has a convenient recursive structure which may lead to an adaptable combinatorial interpretation.

4.4 Interpretations for Step Tableaux

We now consider the class of step tableaux which have a convenient recursive structure for computing characters.

Definition 27 (Step Tableaux). *We denote a step tableau on $[n]$, \mathcal{ST}_n as a tableau where the number of blocks in each row decreases by 1 each time.*

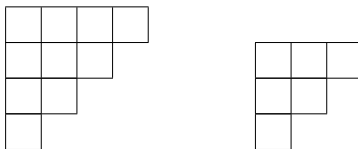

Figure 4.5: Step Tableaux $\lambda = (4, 3, 2, 1)$ and $\mu = (3, 2, 1)$

Claim 3. (Recursive Structure for Step Tableaux).

Consider a step tableau on $[n]$ with largest step size k . Then by removing a rim hook of size $2k - 1$ we are left with either a step tableau on $[n - 2k - 1]$ or a hook of size 3.

Proof. For a step tableau the number of boxes in each row are $\lambda = (k, k-1, k-2, \dots, 3, 2, 1)$. There is only one possible way to remove a rim hook of size $2k - 1$ by deleting two boxes from rows 1 to $k - 1$ and one cell from row k . Thus we are left with the following row entries $(k - 2, k - 3, k - 4, \dots, 1, 0, 0)$, which defines a step tableau with largest step $k - 2$. □

The interpretation using path tableaux by Clearman, Shelton, and Skandera does not extend to the case of step tableaux. However, we suggest some modifications and show in small cases a possible combinatorial interpretation.

Conjecture 2. (Step Tableaux). *Due to the recursive structure of step tableaux, we conjecture that there is a concise combinatorial interpretation in terms of path tableaux, using the recursive structure from Chapter 3. In particular, we conjecture that the combinatorial interpretation using the recursive structure is related to the number of semistandard skew tableaux of the shape of the rim hook of size $2k - 1$.*

This concludes the new material for this thesis. The next chapter provides a conclusion and details some areas for future research on the combinatorics of the immanant function.

Chapter 5

Future Work, Related Problems, and Conclusions

This section summarizes the results and methodology that have been used throughout this thesis. We begin with a formal summary of the content, followed by a description of contributions and the methods that were implemented. In addition, we describe a number of potential areas for future research and outline some of the outlying open problems in this field. Finally, we discuss some of the areas of research that concurrently being investigated with regards to the immanant function.

The scope of this thesis attempts to extend the combinatorial interpretations for the immanant. We do this by considering the algebraic and combinatorial components of the immanant and making extensions on previous research done in the field. We begin with a summary of the thesis and the contributions followed by some future conjectures and other areas of interest in this field.

5.1 Summary of Contributions

We began this thesis by giving an overview some basic symmetric functions and the combinatorics of the immanant. The complexity of the immanant makes this a valid subject for research interest, as computing the immanant is a non-trivial task, and finding a combinatorial interpretation may assist in illuminating certain properties of the immanant.

Our methodology in this thesis was to consider the previous combinatorial interpretations of the immanant and attempt to extend these using algebraic methods. We began by examining the common interpretations for the permanent in terms of matchings in a bipartite graph and cycle covers in directed graphs. We then considered the interpretation for the determinant by Gessel, Viennot, and Lindström in terms of lattice paths. We then progressed to interpretations of the immanant, demonstrating two interpretations for specific matrices, the Jacobi-Trudi matrix and the matrix associated with the Matrix Tree Theorem. We then described the Temperley-Lieb algebra and an interpretation of the elementary immanants using this algebra.

From this we then considered the interpretation by Clearman, Shelton, and Skandera [8] using path tableaux and R -weighted planar networks to interpret monomial and elementary immanants. We then presented the extension from Clearman, Shelton, and Skandera to the interpretation for irreducible character immanants indexed by a hook tableau.

In Chapter 3 we considered the algebraic component of computing the immanant. We discussed the recursive formula for the symmetric group and characters using the Murnaghan-Nakayama Rule. These recursive formulations were then used in Chapter 3 to obtain a recursive formulation for the immanant and to introduce the weighted immanant.

In Chapter 4 we presented original combinatorial results using the path tableaux and R -weighted planar network construction. These results include an interpretation for immanants of triangular and block triangular matrices using path tableaux. In addition, we stated theorems for interpretations of the permanent using standard path tableaux. We then presented a corollary stating a restriction of the Gessel, Viennot, and Lindström using R -weighted planar networks.

In the next section, we progressed to combinatorial interpretations for irreducible character immanants indexed by certain classes of tableaux. We discussed a combinatorial interpretation for $2 \times m$ or $m \times 2$ rectangular tableaux, as well as addition of boxes to hook tableaux. We then presented a recursive structure for step tableaux and provided a conjecture for a combinatorial interpretation based on this recursive structure.

We now conclude with some interesting related research in this field as well as discuss potential future research from this work.

5.1.1 Related Research

There are a number of other areas of research interest involving the immanant. We discuss some of the more recent developments in research involving the immanant. We present the topics that may be of interest as possible fields in which the research presented in this thesis may be extended.

There has been significant research interest on the subject of quantum immanants. Here instead of using irreducible characters of the symmetric group, characters of $H_n(q)$, the Hecke algebra of type A are used. In a recent paper, Konvalinka [24] proved that the coefficients of the quantum immanants in the quantum permutation space are class functions.

Quantum immanants have a similar structure to irreducible character immanants and also have a recursion for the character function. These similarities would make our methods of interest in this research area. There are still several open problems in this area as results have mainly been limited to permutations with minimal length in their conjugacy class [24]. Therefore there are many opportunities to expand the research in this area, using the research in this thesis.

There has also been interest in research on linear operators which preserve the immanant. A recent paper by Purificação Coelho and Duffner [29], considers the class irreducible character immanants of skew-symmetric complex matrices, and which operations preserve the immanant. There may be room to expand this interpretation to other classes of matrices using linear operators.

In addition, there has been research done on the stabilizers of immanants using the stabilizers of the Lie algebra. Ye [38] built on the works of Purificação Coelho and Duffner [29] to show that for any homogeneous polynomial of degree n on a specific space of $n \times n$ matrices is a linear combination of immanants. There is still a significant amount of research to be done in this area and the research surrounding the immanant continues to spread across several areas of mathematics.

5.2 Future Research

We now present some further conjectures based on preliminary computational results. Additionally, we discuss some of the remaining open problems relating to the combinatorics of the immanant and its specializations.

5.2.1 Further Combinatorial Interpretations

We shall now consider some possible further applications of these results. This thesis in its entirety, mainly attempted to glean information about the potential advantages of considering the immanant using a recursion. We have shown in Chapters 3 and 4 that this may be effective in establishing a recursive and more general combinatorial interpretation. There are still several developments that may be made in this area of research, some of which we outline below.

The first remaining open problem is that of finding a general combinatorial interpretation for the immanant for any class of matrices. Since for any matrix in $M_n(F)$, a corresponding R -weighted planar network can be constructed [8], this combinatorial representation is an excellent building block for finding future combinatorial interpretations for the immanant. Therefore the main open problem in this area is to find a graph theoretic interpretation for $\text{Imm}_\lambda(A)$, indexed by a partition λ , where A is the path matrix of an R -weighted planar network of order n .

In addition, we believe that for the class of block diagonal matrices, there may be a simple interpretation in terms of path tableaux and planar networks. In addition to the general interpretation for block triangular matrices, several preliminary computations were completed considering the class of block diagonal matrices over rectangular tableaux and other shapes and has been consistent in many cases.

In Chapter 5, we presented an interpretation for $2 \times m$ and $m \times 2$ rectangular tableaux in terms of the underlying recursive structure for hook tableaux. From this, a next future step is to consider the interpretation for general rectangular tableaux of different dimensions.

Clearman, Shelton, and Skandera had interpretations of the elementary character immanants in terms of the Temperley-Lieb algebra. This interpretation considered the class of partitions with two parts and used colourings of $\mathfrak{TL}_n(2)$ to interpret the corresponding immanants. Another area of potential research is to expand the interpretation for elementary immanants to general partitions, and to consider other classes of immanants such as the monomial and irreducible character immanants in terms of elements of this algebra.

Another open problem is to find a closed form combinatorial interpretation for the class of monomial immanants. In particular, it would be beneficial to find a combinatorial interpretation for, $\text{Imm}_{\phi^\lambda}$, for all tableaux λ using path tableaux and R -weighed planar networks.

Additionally, there are still several open problems concerning the positivity of the immanant. For example, for a TNN matrix A , can we find a graph theoretic interpretation for the nonnegative number $\text{Imm}_\lambda(A)$. In addition, we can also attempt to find a combinatorial interpretation using MNN symmetric functions for $\text{Imm}_\lambda(H(\nu, \mu))$. Another open problem relating to the monomial immanant is to determine if $\text{Imm}_{\phi^\lambda}$ is TNN and SNN.

5.2.2 Conclusions

In conclusion, we considered combinatorial interpretations of the immanant function using a recursive construction and path tableaux of R -weighted planar networks. We developed some general interpretations for classes of matrices and some tableaux specific interpretations. However, the present state of affairs is that there is no combinatorial interpretation for the immanant in general, leaving this and other combinatorial interpretations as an open problem.

APPENDICES

Appendix A

Maple Code for Immanants and Planar Networks

The two main programs used for this thesis are listed below. Both of these program are run in Maple, however a small portion of coding used Sage with the following commands:

```
sage.combinat.combinat.CombinatorialClass
sage.combinat.tableau.SemistandardTableaux(p=None,mu=None, max_entry=None)
SemistandardTableaux(p, mu).cardinality()
```

A.1 Code

A.1.1 Immanant Module

```
Imma := module ()
export L, S, permvaluecyclic, permvalue, M, mult, multM, par,
input, totalin, total, partin, part, Imm, ImmM, ImmP, ImmMP;
option package;
L := proc (n) with(combinat); [[seq(i, i = 1 .. n)]] end proc;
S := proc (n) with(group);
eval(elements(permgroupp(n, {L(n), [[1, 2]]}))) end proc;
permvaluecyclic := proc (A::list, i0)
local j, k, n; n := nops(op(1, A));
```

```

for j to n-1 do:
  if i0 = op(j, op(1, A)) then RETURN(op(j+1, op(1, A)))
end if;
end do;
if i0 = op(n, op(1, A)) then RETURN(op(1, op(1, A))) end if;
RETURN(i0)
end proc;
permvalue := proc (A::list, i0) local j, n, temp;
n := nops(A);
temp := i0;
if n = 1 then RETURN(permvaluecyclic(A, i0)) end if;
for j to n do
temp := permvaluecyclic([op(j, A)], temp)
end do;
RETURN(temp)
end proc;
M := proc (n) Matrix(n, m) end proc;
mult := proc (A, n) mul(M(n)[i, permvalue(A, i)], i = 1 .. n) end proc;
multM := proc (A, n, M) mul(M[i, permvalue(A, i)], i = 1 .. n) end proc;
par := proc (n, i) sort(map(nops, S(n)[i])) end proc;
input := proc (a) sort(map(nops, a)) end proc;
totalin := proc (a) add(input(a)[j], j = 1 .. nops(input(a))) end proc;
total := proc (n, i) add(par(n, i)[j], j = 1 .. nops(par(n, i))) end proc;
partin := proc (a, n) local p, m, w, k, r;
if totalin(a) = n then return sort(input(a))
else
m := n-totalin(a);
w := [seq(1, k = 1 .. m)];
p := [op(input(a)), op(w)];
r := sort(p); return r end if
end proc;
part := proc (n, i) local p, m, w, k, r;
if total(n, i) = n then return sort(par(n, i))
else
m := n-total(n, i);
w := [seq(1, k = 1 .. m)];
p := [op(par(n, i)), op(w)]; r := sort(p); return r end if
end proc;

```

```

Imm := proc (A, j)
add(Chi(partin(A, j), part(j, i))*mult(S(j)[i], j), i = 1 .. factorial(j))
end proc;
ImmM := proc (A, j, M)
add(Chi(partin(A, j), part(j, i))*multM(S(j)[i], j, M), i = 1 .. factorial(j));
end proc;
ImmP := proc (A, j)
add(Chi(A, part(j, i))*mult(S(j)[i], j), i = 1 .. factorial(j));
end proc;
ImmMP := proc (A, j, M)
add(Chi(A, part(j, i))*multM(S(j)[i], j, M), i = 1 .. factorial(j)) ;
end proc ;
end module;

```

A.1.2 Planar Network Module

```

PlanarNetwork10 := module ()
export roll, H, V, Path, Skel, Skeleton, PathWeight, PathWeightMatrix,
Posets, PTMult, Eset, FinalSum;
option package;
with(LinearAlgebra): with(GraphTheory): with(networks): with(Imma):
Path := proc (G, i, j) local res;
try
res[i, j] := ShortestPath(G, a[i], b[j])
catch:
res[i, j] := 0
end try;
end proc;
Skel := proc (G, i, j)
local res;
try
res[i, j] := Graph(Path(G, i, j), Trail(Path(G, i, j)), weighted, directed)
catch:
res[i, j] := 0
end try;
end proc;

```

```

PathWeight := proc (G1, i, j)
local E, F, H, r, res;
try
res[i, j] := nops(Edges(Skel(G1, i, j)))
catch:
res[i, j] := 0; return 0
end try;
E := nops(Edges(Skel(G1, i, j)));
H := [];
for r from 1 to E do
F := GetEdgeWeight(G1, Edges(Skel(G1, i, j))[r]);
H := [op(H), F] end do;
try
res[i, j] := mul(k, k = op(H))
catch:
res[i, j] := op(H)
end try;
end proc;
PathWeightMatrix := proc (Graph1, n) local f;
f := proc (i, j) options operator, arrow;
PathWeight(Graph1, i, j) end proc;
Matrix(n, f)
end proc;
Skeleton := proc (G, i) local E, F, j, FinalGraph;
E := [];
for j to i do
F := Trail(Path(G, j, j));
E := [op(E), F]
end do;
FinalGraph := Graph(Vertices(G), op(E))
end proc;
Posets := proc (G, n)
local i, j, k, In, P, Q;
Q := proc (i) {op(Path(G, i, i))}
end proc;
P[1] := 1;
for j to n do
for k from j+1 to n do

```



```

In := 'intersect'(Q(j), Q(k));
if
In <> {} then P[k] := P[j]
else
P[k] := P[j]+1
end if
end do end do;
return [seq(P[i], i = 1 .. n)]
end proc;
PTMult := proc (G, n)
local res, a, r, i, Z, b;
a := Posets(G, n);
r := max(a);
Z := [];
for i to r do b := numboccur(a, i);
Z := [op(Z), factorial(b)] end do;
try
res[i, j] := mul(Z[q], q = 1 .. nops(Z)) ;
catch: res[i, j] := op(Z);
end try;
end proc;
Eset := proc (A, n) local Z3, Z2, Z, Q, i, j, k, l, f, g, w, maxw;
Q := [];
w := 'minus'({op(Vertices(A))}, {seq(a[d], d = 1 .. n), seq(b[e], e = 1 .. n)});
maxw := max(w);
for i to n do for j to n do
Z := [a[i], a[j]], [b[i], b[j]];
Q := [op(Q), Z]
end do
end do;
for k to n do
for l to n do
Z2 := [b[k], a[l]];
Q := {op(Q), Z2}
end do end do;
for f to n do
for g to maxw do Z3 := [b[f], g], [g, a[f]];
Q := {op(Q), Z3} end do end do;

```

```
return 'intersect'(Edges(A), Q), Q
end proc;
FinalSum := proc (G, n, CountPT)
local Z, i;
Z := mul(PathWeight(G, i, i), i = 1 .. n);
CountPT*Z;
end proc;
end module;
```

Bibliography

- [1] H. Barcelo and A. Ram. *Combinatorial Representation Theory*. MSRI preprint. Mathematical Sciences Research Institute, 1997.
- [2] J.A. Beachy. *Introductory Lectures on Rings and Modules*. London Mathematical Society Student Texts. Cambridge University Press, 1999.
- [3] A. Ben-Dor and S. Halevi. Zero-one permanent is NP-complete, a simpler proof. In *Theory and Computing Systems, 1993., Proceedings of the 2nd Israel Symposium on the*, pages 108–117, jun 1993.
- [4] J. Brylinski and R. Brylinski. Complexity and completeness of immanants. <http://arxiv.org/abs/cs/0301024>.
- [5] P. Bürgisser. The computational complexity of immanants. *SIAM J. Comput.*, 30(3):1023–1040 (electronic), 2000.
- [6] S. Cautis and D. M. Jackson. The matrix of chromatic joins and the Temperley-Lieb algebra. *J. Combin. Theory Ser. B*, 89(1):109–155, 2003.
- [7] S. Clearman, B. Shelton, and M. Skandera. Combinatorial interpretations for special cases of monomial immanants and irreducible character immanants. *Preprint*, 2011.
- [8] S. Clearman, B. Shelton, and M. Skandera. Path Tableaux and Combinatorial Interpretations of Immanants for class functions on S_n . In *23rd International Conference on Formal Power Series and Algebraic Combinatorics (FPSAC 2011)*, Discrete Math. Theor. Comput. Sci. Proc., AO, pages 233–244. Assoc. Discrete Math. Theor. Comput. Sci., Nancy, 2011.
- [9] P. Diaconis and S. Evans. Immanants and finite point processes. *J. Combin. Theory Ser. A*, 91(1-2):305–321, 2000. In memory of Gian-Carlo Rota.

- [10] R. Diestel. *Graph Theory*, volume 173 of *Graduate Texts in Mathematics*. Springer, Heidelberg, fourth edition, 2010.
- [11] G.W. Bennett D.M. Jackson. Linear algebra with advanced topics. *Private communication*.
- [12] G. Frobenius. *Über die Charaktere der symmetrischen Gruppe*. Reimer, 1900.
- [13] I. Gessel and G. Viennot. Binomial determinants, paths, and hook length formulae. *Adv. in Math.*, 58(3):300–321, 1985.
- [14] I. P. Goulden and D. M. Jackson. Immanants of combinatorial matrices. *J. Algebra*, 148(2):305–324, 1992.
- [15] I. P. Goulden and D. M. Jackson. Immanants, schur functions, and the macmahon master theorem. *Proceedings of the American Mathematical Society*, 115(3):pp. 605–612, 1992.
- [16] I. P. Goulden and D. M. Jackson. *Combinatorial enumeration*. Dover Publications Inc., Mineola, NY, 2004. With a foreword by Gian-Carlo Rota, Reprint of the 1983 original.
- [17] I.P. Goulden, K. Purbhoo, and D.G. Wagner. CO 630 course notes. *Faculty of Mathematics, University of Waterloo*, 2010.
- [18] C. Greene. Proof of a Conjecture on Immanants of the Jacobi-Trudi matrix. *Linear Algebra Appl.*, 171:65–79, 1992.
- [19] M. Haiman. Hecke Algebra Characters and Immanant Conjectures. *J. Amer. Math. Soc.*, 6:569–595, 1993.
- [20] F. Harary. Determinants, permanents and bipartite graphs. *Math. Mag.*, 42:146–148, 1969.
- [21] G. James and A. Kerber. *The representation theory of the symmetric group*, volume 16 of *Encyclopedia of Mathematics and its Applications*. Addison-Wesley Publishing Co., Reading, Mass., 1981. With a foreword by P. M. Cohn, With an introduction by Gilbert de B. Robinson.
- [22] S. Karlin and J. McGregor. Coincidence probabilities. *Pacific J. Math.*, 9:1141–1164, 1959.

- [23] M. Konvalinka. On Goulden-Jackson’s determinantal formula for the immanant. *Ann. Comb.*, 13(4):511–518, 2010.
- [24] M. Konvalinka. On quantum immanants and the cycle basis of the quantum permutation space. *Ann. Comb.*, 16(2):289–304, 2012.
- [25] B. Lindström. On the vector representations of induced matroids. *Bull. London Math. Soc.*, 5:85–90, 1973.
- [26] D. E. Littlewood. *The Theory of Group Characters and Matrix Representations of Groups*. Oxford University Press, New York, 1940.
- [27] D. E. Littlewood and A. R. Richardson. Group characters and algebra. *Philosophical Transactions of the Royal Society of London. Series A, Containing Papers of a Mathematical or Physical Character*, 233:pp. 99–141, 1934.
- [28] G. Malod and N. Portier. Characterizing Valiant’s algebraic complexity classes. *J. Complexity*, 24(1):16–38, 2008.
- [29] M. Purificação Coelho and M. Duffner. Linear preservers of immanants on skew-symmetric matrices. *Linear Algebra Appl.*, 436(7):2536–2553, 2012.
- [30] B. Rhoades and M. Skandera. Temperley-Lieb immanants. *Ann. Comb.*, 9(4):451–494, 2005.
- [31] B. Rhoades and M. Skandera. Kazhdan-Lusztig immanants and products of matrix minors. II. *Linear Multilinear Algebra*, 58(1-2):137–150, 2010.
- [32] B. E. Sagan. *The Symmetric Group*. The Wadsworth & Brooks/Cole Mathematics Series. Wadsworth & Brooks/Cole Advanced Books & Software, Pacific Grove, CA, 1991. Representations, combinatorial algorithms, and symmetric functions.
- [33] R. P. Stanley and J. R. Stembridge. On immanants of Jacobi-Trudi matrices and permutations with restricted position. *J. Combin. Theory Ser. A*, 62(2):261–279, 1993.
- [34] J. R. Stembridge. Immanants of totally positive matrices are nonnegative. *Bull. London Math. Soc.*, 23(5):422–428, 1991.
- [35] J. R. Stembridge. Some conjectures for immanants. *Canad. J. Math.*, 44(5):1079–1099, 1992.

- [36] W. T. Tutte. *Graph theory*, volume 21 of *Encyclopedia of Mathematics and its Applications*. Cambridge University Press, Cambridge, 2001. With a foreword by Crispin St. J. A. Nash-Williams, Reprint of the 1984 original.
- [37] L. G. Valiant. The complexity of computing the permanent. *Theoret. Comput. Sci.*, 8(2):189–201, 1979.
- [38] K. Ye. The stabilizer of immanants. *Linear Algebra Appl.*, 435(5):1085–1098, 2011.